



TOMASEFFA

**COMPLEMENTI**  
DESIGN COLLECTION

# COMPLEMENTI

## DESIGN COLLECTION

indice / contents	2
tavoli / tables	8
sedie / chairs	64
madie / sideboards	88
poltrone e pouf / armchairs and poufs	168
tavolini / coffee tables	202
specchi / mirrors	236
accessori / accessories	250
wallpaper	320
pagine tecniche / technical pages	330
pagine di sintesi / summary	337



tavoli / tables



plinto p. 10



avalon p. 14



tudor p. 24



brigitte p. 32



bloom p. 40



doppio passo p. 48



infinity p. 56

sedie/ chairs



york p. 66



lolita p. 68



lola p. 72



bea p. 74



time p. 76



betty p. 78



skinny p. 80



tiffany p. 82



tiffany gonna p. 86

madie / sideboards



sir p. 90



regolo p. 98



remix p. 108



metropolis p. 116



diagonal p. 134



athena p. 150



madison p. 160



atlante p. 164

poltrone & pouf / armchairs & ottomans



loft p. 170



flower p. 176



soft p. 180



maya p. 184



vanessa p. 188



linda p. 190



cookie p. 192



giglio p. 196



guccino p. 198



comodo p. 200

tavolini / coffee and side tables



joy p. 204



joy decor p. 208



joy wood p. 210



caruso p. 212



eclisse p. 214



brigitte p. 216



strike p. 222



bloom p. 226



flexo p. 230

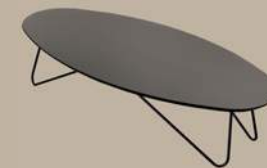

senzatempo p. 232



33 p. 234

specchi / mirrors



bolle p. 238



inside p. 240



hashtag p. 242



vip p. 246



dolcevita p. 248

accessori / accessories



kalista p. 252

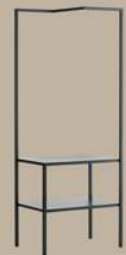

kalista midi p. 254



kalista fianco p. 255



movida p. 256



raster p. 260



ring p. 264



ciko p. 266



petalo p. 270



scrittoio p. 272



panketta p. 278



tasca p. 282



toilette replay p. 284

accessori / accessories



shape p. 286



ingressi p. 292



up&down p. 294



orologi p. 296



lettering p. 298



quadri p. 300



tappeti p. 311



plaid p. 317



cuscini p. 318



wallpaper p. 320



# tavoli

tables

Trascorrere del tempo in famiglia o con gli amici a tavola è un'abitudine da apprezzare e coltivare. Protagonista della convivialità, scegliere il tavolo giusto è il primo passo per portare nel living il piacere di stare insieme.

Spending time around the table with family and friends is a treat best served regularly! Finding the right table - the centrepiece of the gathering - is the first step towards bringing the joy of entertaining and family time into your living spaces.





PLINTO





**Pagina precedente**  
 Tavolo Plinto piano vetro trasparente 320, struttura legno rovere termocotto e metallo antracite 160.  
 L 240 P 110 H 75 cm  
 Sedie York struttura legno rovere termocotto, rivestimento cat.b econabuk 12.  
 L 47 P 61 H 92/48 cm  
 Sedia Lola struttura legno rovere termocotto, rivestimento cat.c lino froissè 123.  
 L 55 P 53 H 81/47 cm  
 Madia sospesa Sir S02 struttura laccato opaco salvia 159 e legno rovere termocotto.  
 L 270 P 40 H 54 cm

**Preceding page**  
 Plinto table with transparent 320 glass top, heat-treated oak wood and anthracite 160 metal frame.  
 L 240 W 110 H 75 cm  
 York chairs with a heat-treated oak wood frame upholstered with cat. b eco-nubuck 12.  
 W 47 D 61 H 92/48 cm  
 Lola chair with heat-treated oak frame upholstered with cat. c froissè linen 123 fabric.  
 W 55 D 53 H 81/47 cm  
 Wall-hung Sir S02 sideboard with a matt sage 159 lacquered carcass and heat-treated oak wood.  
 W 270 D 40 H 54 cm

## PLINTO

misure / size

L/W200 P/D 100 H 75 cm

L/W240 P/D 110 H 75 cm

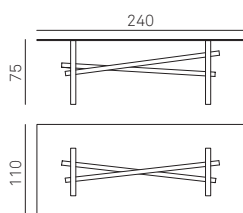
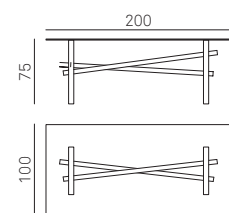

### FINITURE PIANO / TOP FINISHES

VETRO / GLASS



320

Vetro Trasparente  
Transparent glass

### FINITURE GAMBE / LEG FINISHES

ESSENZE / WOOD FINISHES



**LGN-FO**  
Frassino Oriente  
Eastern Ash



**LGN-RT**  
Rovere termocotto  
Heat-treated Oak

LEGNO NATURALE / NATURAL WOOD

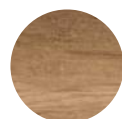

Rovere Nodato naturale  
Natural knotted oak

LACCATI / LACQUERS



**colori laccati opachi a campionario**  
(vedi pagina 333)  
choice of matt lacquer colours  
from our range (see page 333)

### FINITURE CILINDRI / CYLINDERS FINISHES

METALLO / METAL



Antracite 160  
Anthracite 160





AVALON







< **Pagina precedente**  
 Tavolo Avalon piano Hpl 12, struttura legno  
 laccato poro aperto antracite 260.  
 L 240 P 120 H 75 cm  
 Sedie Betty cat. b ecopelle extrema 16.  
 L 45 P 54 H 81/46 cm  
 Madie Regolo R03 struttura materico opaco  
 bianco gesso, inserto maniglia materico opaco  
 antracite e metallo antracite 160.  
 L 108 P 40 H 147,5 cm  
 Tappeto Gradient.

**Preceding page**  
 Avalon table with an HPL 12 top and an open-  
 pore anthracite 260 lacquered wood frame.  
 L 240 W 120 H 75 cm  
 Betty chairs upholstered with cat. b extrema  
 16 eco-leather.  
 W 45 D 54 H 81/46 cm  
 Regolo R03 sideboards with a textured  
 matt chalk white carcass and textured matt  
 anthracite and anthracite 160 metal handle  
 insert.  
 W 108 D 40 H 147.5 cm  
 Gradient rug.







Tavolo Avalon piano Hpl 11, struttura legno laccato poro aperto antracite 260.  
L 240 P 120 H 75 cm

Sedie Bea struttura legno rovere termocotto.  
L 42 P 53 H 78/44 cm

Contenitori sospesi Atlante laccato opaco antracite 160.  
L 288 P 40 H 37,4 cm

Tappeto Black & White.

Wallpaper WPT 553.

Avalon table with an HPL 11 top and an open-pore anthracite 260 lacquered wood frame.  
L 240 W 120 H 75 cm

Bea chairs with a heat-treated oak wood frame.  
W 42 D 53 H 78/44 cm

Wall-hung Atlante units in matt anthracite 160 lacquer.  
W 288 D 40 H 37.4 cm

Black & White rug.

WPT 553 wallpaper.



## AVALON

Tavolo Avalon piano materico cemento chiaro, struttura legno laccato poro aperto antracite 260.  
L 240 P 120 H 76,8 cm

Sedie York struttura legno laccato poro aperto antracite 260, rivestimento cat. b ecopelle vintage 101.  
L 47 P 61 H 92/48 cm

Avalon table with a light textured cement top and an open-pore anthracite 260 lacquered wood frame.  
L 240 W 120 H 76,8 cm

York chairs with an open-pore anthracite 260 lacquered wood frame upholstered with cat. b vintage 101 eco-leather.  
W 47 D 61 H 92/48 cm



## AVALON

misure / size

L/W 180 P/D 100 H 75 cm  
L/W 200 P/D 110 H 75 cm  
L/W 240 P/D 120 H 75 cm

misure al centimetro / custom-sized

L/W 180 ÷ 240 cm solo con piano materico laccato opaco e poro aperto  
P/D 100 ÷ 120 cm only for textured top matt lacquered and open pore

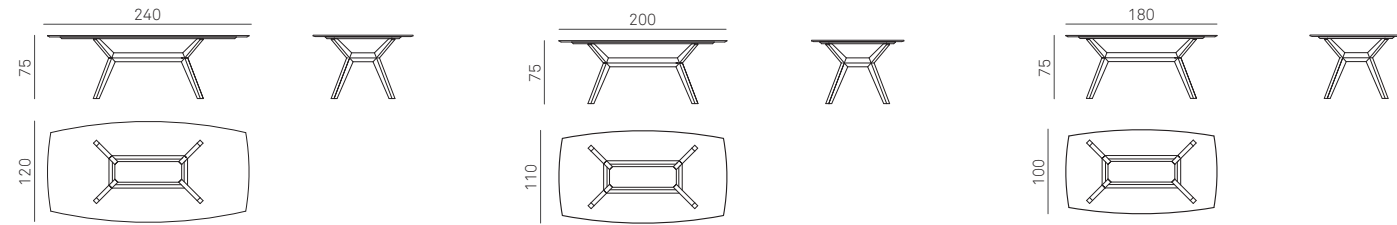

### FINITURE PIANO / TOP FINISHES

MATERICO ESSENZA / TEXTURED WOOD



**MT-FO**  
Frassino Oriente  
Eastern Ash



**MT-RT**  
Rovere termocotto  
Heat-treated Oak

MATERICO NODATO / KNOTTED TEXTURED



**MT-RNC**  
Nodato chiaro  
Light Knotted



**MT-RNS**  
Nodato scuro  
Dark knotted

MATERICO / TEXTURED



**MT-CC**  
Cemento chiaro  
Light cement



**MT-CS**  
Cemento scuro  
Dark cement

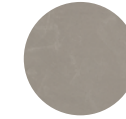

**MT-CV**  
Cemento Cava  
Cava cement

HPL

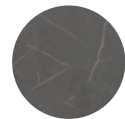

**HPL**  
11



**HPL**  
12

LEGNO LACCATO PORO APERTO / OPEN-PORE LACQUERED WOOD



**221 PA**  
Bianco Gesso  
Chalk white



**222 PA**  
Panna  
Cream



**224 PA**  
Madreperla  
Mother of pearl



**227 PA**  
Hot  
Hot grey



**230 PA**  
Grigio Piacenza  
Piacenza grey



**250 PA**  
Canapa  
Hemp

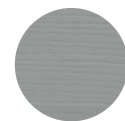

**252 PA**  
Pomice  
Pumice

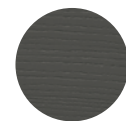

**260 PA**  
Antracite  
Anthracite

LACCATI / LACQUERS

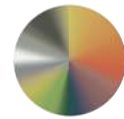

colori laccati opachi a campionario  
(vedi pagina 333)  
choice of matt lacquer colours  
from our range (see page 333)

### FINITURE STRUTTURA / BASE FINISHES

LEGNO LACCATO PORO APERTO / OPEN PORE LACQUERED WOOD

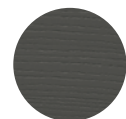

**260 PA**  
Antracite  
Anthracite





TUDOR





## TUDOR ALLUNGABILE

Tavolo Tudor chiuso / Shut Tudor table



Tavolo Tudor con una allunga / Tudor table with one extension



Tavolo Tudor con due allunghe / Tudor table with two extensions



← **Pagina precedente**  
Tavolo Tudor piano rovere naturale scortecciato, struttura metallo antracite 160 e metallo bianco gesso 121.  
L 350 P 110 H 74 cm  
Sedie Betty cat. b ecopelle vintage 1009.  
L 45 P 54 H 81/46 cm  
Tappeto Dots.

**Preceding page**  
Tudor table with a stripped natural oak top and an anthracite 160 metal and chalk white 121 metal frame.  
L 350 W 110 H 74 cm  
Betty chairs upholstered with cat. b vintage 1009 eco-leather.  
W 45 D 54 H 81/46 cm  
Dots rug.







## TUDOR

Tavolo Tudor piano legno rovere naturale scortecciato, struttura metallo antracite 160 e metallo bordeaux 156.  
L 350 P 110 H 74 cm

Sedie Tiffany Gonna cat. c lino froissé 019.  
L 46 P 50 H 83/47 cm

Wallpaper WPT 553.

Tudor table with a stripped natural oak wood top and an anthracite 160 metal and burgundy 156 metal frame.  
L 350 W 110 H 74 cm

Tiffany Gonna chairs in cat. c froissé linen 019 fabric.

W 46 D 50 H 83/47 cm

WPT 553 wallpaper.





Variante con basamento in vetro.  
Version with glass base.



## TUDOR

misure / size **tudor fisso / fixed**

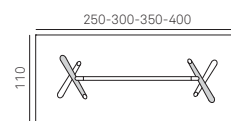
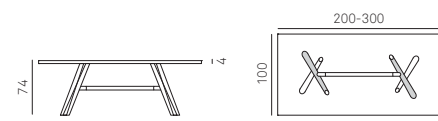

**tudor allungabile / extending**

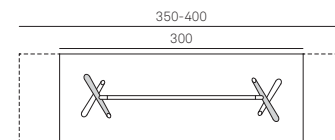
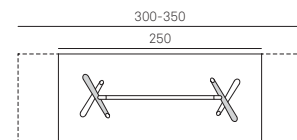
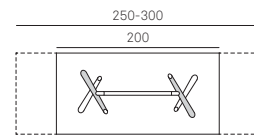

### FINITURE TOP / TOP FINISHES

ESSENZE / WOOD FINISHES



Rovere naturale  
scortecciato  
Stripped natural oak

### FINITURE STRUTTURA / BASE FINISHES

DI SERIE FINITURA ANTRACITE CON PARTICOLARE GAMBA PERSONALIZZABILE IN COLORE LACCATO OPACO  
ANTHRACITE FINISH AS STANDARD WITH LEG DETAIL IN YOUR CHOICE OF MATT LACQUERED FINISH



Antracite 160  
Anthracite 160

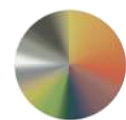

Gamba personalizzabile colori laccati opachi a  
campionario (vedi pagina 333)  
Customisable leg choice of matt lacquer colours  
from our range (see page 333)



## BRIGITTE



Tavolo Brigitte piano materico nodato scuro, struttura metallo antracite 160. Ø 120 H 75 cm.

Sedia Betty cat. 1/one atom 10. L 45 P 54 H 81/46 cm.

Libreria Movida struttura metallo antracite 160, ripiani materico nodato scuro. L 74 P 38 H 190 cm.

Brigitte table with textured dark knotted top and anthracite 160 metal frame. Ø 120 H 75 cm.

Betty chair upholstered with cat. 1/one atom 10. W 45 D 54 H 81/46 cm.

Movida bookcase with anthracite 160 metal frame and textured dark knotted shelves. W 74 D 38 H 190 cm.





## BRIGITTE

Tavolo Brigitte piano laccato opaco zafferano 158, struttura metallo zafferano 158.  
Ø 120 H 75 cm

Sedia Tiffany Gonna cat.c lino froissè 019.  
L 46 P 50 H 83/47 cm

Madia Madison laccato opaco antracite 160.  
L 207 P 49 H 76 cm

Tavolino 33 versione 12.  
Ø 40 H 38 cm

Brigitte table with a matt saffron 158  
lacquered top and a saffron 158 metal frame.  
Ø 120 H 75 cm

Tiffany Gonna chair in cat. c froissè linen 019  
fabric.  
W 46 D 50 H 83/47 cm

Matt anthracite 160 lacquered Madison  
sideboard.  
W 207 D 49 H 76 cm

33 coffee table, version 12.  
Ø 40 H 38 cm



BRIGITTE



Piano laccato opaco bordeaux 156, struttura metallo bordeaux 156. Matt burgundy 156 lacquered top, burgundy 156 metal frame.



Piano laccato opaco carta da zucchero 155, struttura metallo carta da zucchero 155. Matt blue grey 155 lacquered top, blue grey 155 metal frame.



Piano grafica 360, struttura metallo salvia 159. Graphic 360 top, sage 159 metal frame.



Piano laccato opaco smoke 128, struttura peltro. Matt smoke 128 lacquered top, pewter frame.



Piano materico nodato chiaro, struttura metallo bianco gesso 121. Textured light knotted top, chalk white 121 metal frame.



Piano grafica 331, struttura metallo bianco gesso 121. Graphic 331 top, chalk white 121 metal frame.

BRIGITTE

Tavolo Brigitte piano grafica 350, struttura metallo antracite 160. Ø 120 H 75 cm

Sedie Tiffany Gonna cat.c lino froissè 100. L 46 P 50 H 83/47 cm

Tappeto Black & White.

Brigitte table with graphic 350 top and anthracite 160 metal frame. Ø 120 H 75 cm

Tiffany Gonna chairs in cat. c froissè linen 100 fabric. W 46 D 50 H 83/47 cm

Black & White rug.





## BRIGITTE

misure / size Ø 120 H 75 cm

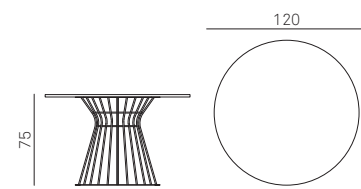

### FINITURE PIANO / TOP FINISHES

#### MATERICO NODATO / KNOTTED TEXTURED



**MT-RNC**  
Nodato chiaro  
Light Knotted

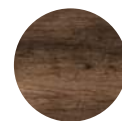

**MT-RNS**  
Nodato scuro  
Dark knotted

#### MATERICO ESSENZA / TEXTURED WOOD



**MT-FO**  
Frassino Oriente  
Eastern Ash



**MT-RT**  
Rovere termocotto  
Heat-treated Oak

#### MATERICO / TEXTURED



**MT-CC**  
Cemento chiaro  
Light cement



**MT-CS**  
Cemento scuro  
Dark cement

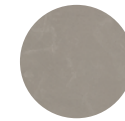

**MT-CV**  
Cemento Cava  
Cava cement

#### LEGNO LACCATO PORO APERTO / OPEN-PORE LACQUERED WOOD



**221 PA**  
Bianco Gesso  
Chalk white



**222 PA**  
Panna  
Cream



**224 PA**  
Madreperla  
Mother of pearl



**227 PA**  
Hot  
Hot grey



**230 PA**  
Grigio Piacenza  
Piacenza grey



**250 PA**  
Canapa  
Hemp

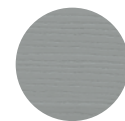

**252 PA**  
Pomice  
Pumice

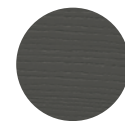

**260 PA**  
Antracite  
Anthracite

#### LACCATI / LACQUERS

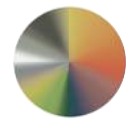

colori laccati  
opachi e lucidi a  
campionario  
(vedi pagina 333)  
choice of matt  
and glossy  
lacquer colours  
from our range  
(see page 333)

### GRAFICHE PIANO / TOP GRAPHIC DESIGNS



302

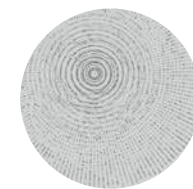

303

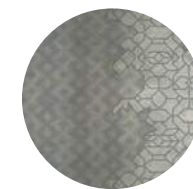

305

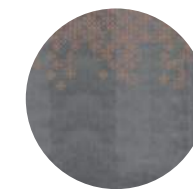

306

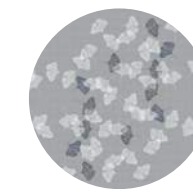

307

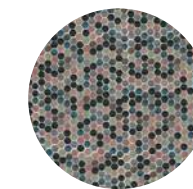

309

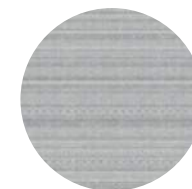

311

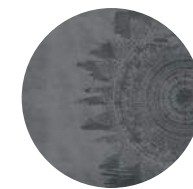

312

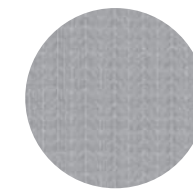

313

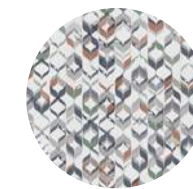

315

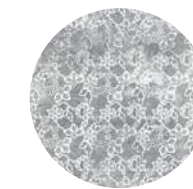

316



330

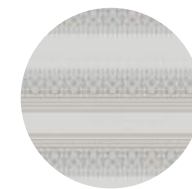

331

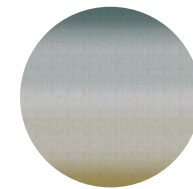

335



350

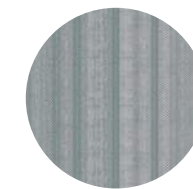

360



## BLOOM

Tavolo Bloom struttura legno rovere termocotto, inserto rame.  
L 220 P 110 H 75 cm

Sedia York struttura legno rovere termocotto, rivestimento cat. b ecopelle vintage 107.  
L 47 P 61 H 92/48 cm

Madia Athena 3 ante struttura laccato opaco pomice 152, inserto vetro antracite 360.  
L 181 P 51 H 85 cm

Bloom table with heat-treated oak frame and copper insert.  
W 220 D 110 H 75 cm

York chairs with a heat-treated oak wood frame upholstered with cat. b vintage 107 eco-leather.  
W 47 D 61 H 92/48 cm

3-door Athena sideboard with a matt pumice 152 lacquered carcass and anthracite 360 glass insert.  
W 181 D 51 H 85 cm





## BLOOM

Tavolo Bloom struttura legno rovere termocotto, inserto rame.  
L 150 P 150 H 75 cm

Sedie York struttura legno rovere termocotto, rivestimento cat. b ecopelle vintage 1011.  
L 47 P 61 H 92/48 cm

Tappeto Gradient.

Bloom table with a heat-treated oak frame and copper insert.  
L 150 W 150 H 75 cm

York chairs with a heat-treated oak wood frame upholstered with cat. b vintage 1011 eco-leather.  
W 47 D 61 H 92/48 cm

Gradient rug.







## BLOOM

Tavolo Bloom piano gres 02, struttura legno rovere termocotto.  
L 220 P 110 H 75 cm

Sedia Lolita struttura legno rovere termocotto, rivestimento cat.b hugo 04.  
L 51 P 56 H 79/47 cm

Sedia Lolita struttura legno rovere termocotto, rivestimento cat.b ecopelle vintage 102.  
L 51 P 56 H 79/47 cm

Sedia Lola struttura legno rovere termocotto, rivestimento cat.b ecopelle extrema 12.  
L 55 P 53 H 81/47 cm

Tappeto Frame.

Bloom table with a stoneware 02 top and a heat-treated oak wood frame.  
L 220 W 110 H 75 cm

Lolita chair with a heat-treated oak wood frame upholstered with cat. b hugo 04.  
W 51 D 56 H 79/47 cm

Lolita chair with a heat-treated oak wood frame upholstered with cat. b vintage 102 eco-leather.  
W 51 D 56 H 79/47 cm

Lola chair with a heat-treated oak wood frame upholstered with cat. b extrema 12 eco-leather.  
W 55 D 53 H 81/47 cm

Frame rug.



## BLOOM

misure / size L/W 220 P/D 110 H 75 cm L/W 150 P/D 150 H 75 cm

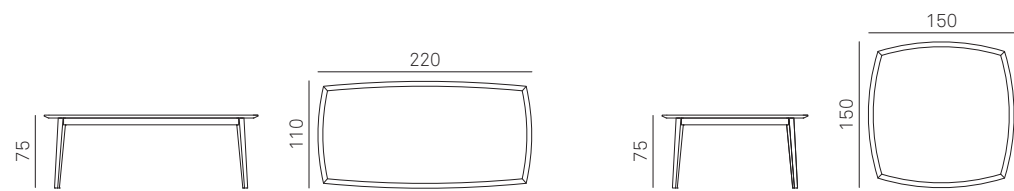

### FINITURE TOP E BASE / BASE AND TOP FINISHES

#### ESSENZE / WOOD FINISHES



**LGN-RT**  
Rovere Termocotto  
Heat-treated Oak

#### GRES PORCELLANATO / PORCELAIN STONEWARE



**Gres 01**  
Gres 01 stoneware



**Gres 02**  
Gres 02 stoneware

### FINITURA INSERTO / INSERT FINISHES

#### INSERTO / INSERT



**Rame**  
Copper

**Non disponibile per piano in gres.**  
Not available for Gres stoneware top.









## DOPPIO PASSO ALLUNGABILE

Tavolo Doppio Passo chiuso / Shut Doppio Passo table



Tavolo Doppio Passo con una allunga / Doppio Passo table with one extension



Tavolo Doppio Passo con due allunghe / Doppio Passo table with two extensions



← **Pagina precedente**  
Tavolo allungabile Doppio Passo struttura legno frassino oriente.  
L 170 (215/260) P 100 H 75 cm

Sedia Skinny cat. B ecopelle vintage 102.  
L 46 P 56 H 95/48 cm

Madia Diagonal Var. A materico frassino oriente, metallo bianco gesso 121.  
L 219 P 51 H 85 cm

Mensole Ring materico frassino oriente e metallo bianco gesso 121.  
L 144 P 26 H 27 cm

Orologio 670.

Tappeto Diagonal.

**Preceding page**  
Doppio Passo extending table with textured eastern ash frame.  
L 160 (205/250) W 90 H 75 cm

Skinny chair upholstered with cat. B vintage 102 eco-leather.  
W 46 D 56 H 95/48 cm

Diagonal Var. A sideboard in textured eastern ash and chalk white 121 metal.  
W 219 D 51 H 85 cm

Ring shelves in textured eastern ash and chalk white 121 metal.  
L 144 D 26 H 27 cm

670 clock.

Diagonal rug.





## DOPPIO PASSO

Tavolo Doppio Passo struttura legno laccato poro aperto hot 227.  
L 170 (215/260) P 100 H 75 cm

Sedie Skinny cat 1/one atom 34.  
L 46 P 56 H 95/48 cm

Madia Atlante laccato opaco hot 127 e specchio grigio 383.  
L 192 P 54 H 76 cm

Pouf Guccino cat. b ecopelle vintage 107 e laccato opaco hot 127.  
Ø 40 H 53 cm

Tappeto Frame.

Doppio Passo table with open-pore hot grey 227 lacquered wood frame.  
L 170 (215/260) W 100 H 75 cm

Skinny cat 1/one atom 34 chairs.  
W 46 D 56 H 95/48 cm

Matt hot grey 127 lacquered Atlante sideboard with grey 383 mirror.  
W 192 D 54 H 76 cm

Guccino pouf upholstered with cat. b vintage 107 eco-leather and lacquered matt hot grey 127.  
Ø 40 H 53 cm

Frame rug.



## DOPPIO PASSO

### Pagina successiva

Tavolo Doppio Passo struttura legno rovere termocotto.  
L 170 (215/260) P 100 H 75 cm

Sedia Lola struttura legno rovere termocotto, cat. b ecopelle extrema 12.  
L 55 P 53 H 81/47 cm

Sedia Lolita struttura legno rovere termocotto, cat. b hugo 04.  
L 51 P 56 H 79/47 cm

### Next page

Doppio Passo table with a heat-treated oak wood frame.  
L 170 (215/260) W 100 H 75 cm

Lola chair with a heat-treated oak wood frame upholstered with cat. b extrema 12 eco-leather.  
W 55 D 53 H 81/47 cm

Lolita chair with a heat-treated oak wood frame upholstered with cat. b hugo 04 fabric.  
W 51 D 56 H 79/47 cm

## DOPPIO PASSO

misure / size

L /W170 (215-260) P/D 100 H 75 cm

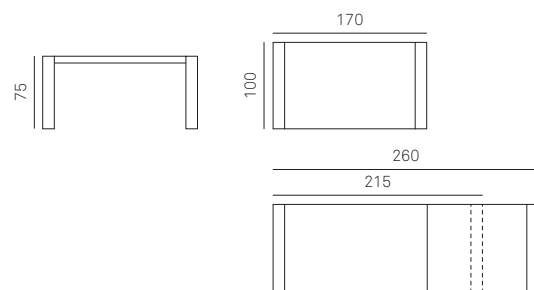

### FINITURE TOP E BASE / BASE AND TOP FINISHES

#### ESSENZE / WOOD FINISHES



**LGN-FO**  
Frassino Oriente  
Eastern Ash



**LGN-RT**  
Rovere Termocotto  
Heat-treated Oak



**MT-RNC**  
Nodato chiaro  
Light Knotted



**MT-RNS**  
Nodato scuro  
Dark knotted



**MT-FO**  
Frassino Oriente  
Eastern Ash



**MT-RT**  
Rovere termocotto  
Heat-treated Oak

#### MATERICO / TEXTURED



**MT-CC**  
Cemento chiaro  
Light cement



**MT-CS**  
Cemento scuro  
Dark cement



**MT-CV**  
Cemento Cava  
Cava cement

#### LEGNO LACCATO PORO APERTO / OPEN PORE LACQUERED WOOD



**221 PA**  
Bianco Gesso  
Chalk white



**222 PA**  
Panna  
Cream



**224 PA**  
Madreperla  
Mother of pearl



**227 PA**  
Hot  
Hot grey



**230 PA**  
Grigio Piacenza  
Piacenza grey



**250 PA**  
Canapa  
Hemp



**252 PA**  
Pomice  
Pumice

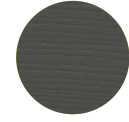

**260 PA**  
Antracite  
Anthracite





## INFINITY

Tavolo Infinity allungabile piano materico cemento scuro, struttura peltro.  
L 280/330-380 P 110 H 75 cm

Sedia Tiffany Gonna cat. b linara 08 e cat. c lino froissè 100.  
L 46 P 50 H 83/47 cm

Pouff Cookie cat. c lino froissè 100 filo 0856.  
L 47 P 47 H 46 cm

Libreria Movida struttura metallo antracite 160, ripiani materico nodato chiaro.  
L 74 P 38 H 190 cm

Extending Infinity table with dark textured cement top and pewter frame.  
L 280/330-380 W 110 H 75 cm

Tiffany Gonna chair in cat. b linara 08 and cat. c froissè linen 100 fabric.  
W 46 D 50 H 83/47 cm

Cookie pouf in cat. c froissè linen 100 fabric, 0856 yarn.  
W 47 D 47 H 46 cm

Movida bookcase with anthracite 160 metal frame and textured light knotted shelves.  
W 74 D 38 H 190 cm





Tante soluzioni. Il tavolo risponde ad esigenze diverse: fisso per chi ha le idee chiare, allungabile per spazi in movimento o su misura per ambienti fuori dagli schemi.

The table caters to different needs: fixed for people who know exactly what they want, extending for ever-changing spaces or custom made for outside-the-box interiors.

## INFINITY

Tavolo Infinity fisso piano materico maya bronze, struttura peltro.  
L 140 P 140 H 75 cm

Sedia York struttura legno rovere termocotto, rivestimento cat. b ecopelle vintage 106.  
L 47 P 61 H 92/48 cm

Libreria Movida struttura metallo antracite 160, ripiani maya bronze.  
L 74 P 38 H 190 cm.

Wallpaper WPT552.

Fixed Infinity table with a textured maya bronze top and a pewter frame.  
L 140 W 140 H 75 cm

York chair with a heat-treated oak wood frame upholstered with cat. b vintage 106 eco-leather.  
W 47 D 61 H 92/48 cm

Movida bookcase with an anthracite 160 metal frame and maya bronze shelves.  
W 74 D 38 H 190 cm.

WPT552 wallpaper.





INFINITY

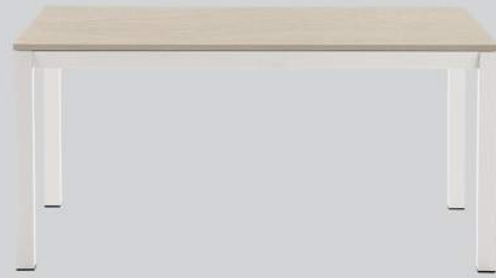

Piano materico frassino oriente, struttura metallo bianco gesso 121.  
Textured eastern ash top, chalk white 121 metal frame.

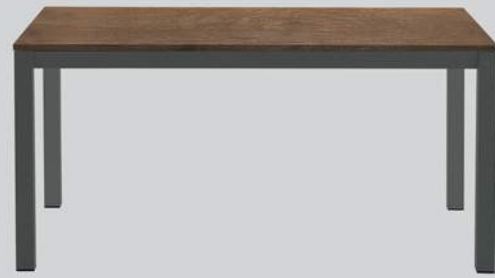

Piano materico nodato scuro, struttura metallo antracite 160.  
Textured dark knotted top, anthracite 160 metal frame.

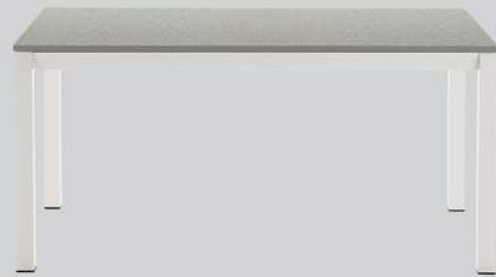

Piano materico cemento chiaro, struttura metallo bianco gesso 121.  
Textured light knotted top, chalk white 121 metal frame.

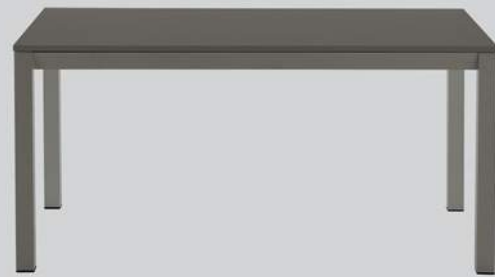

Piano laccato opaco smoke 128, struttura metallo smoke 128.  
Matt smoke 128 lacquered top, smoke 128 metal frame.

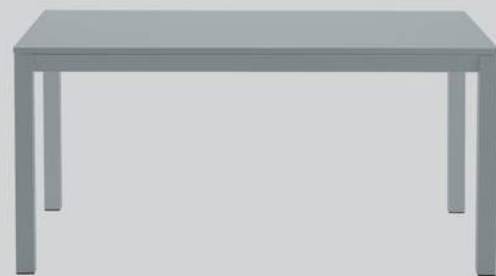

Piano laccato opaco carta da zucchero 155, struttura metallo carta da zucchero 155.  
Matt blue grey 155 lacquered top, blue grey 155 metal frame.

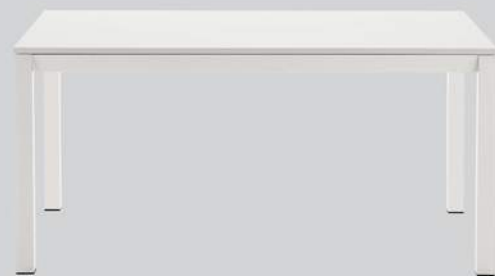

Piano laccato opaco bianco gesso 121, struttura metallo bianco gesso 121.  
Chalk white 121 lacquered top, chalk white 121 metal frame.

INFINITY

Tavolo Infinity piano materico nodato chiaro, struttura metallo bianco gesso 121.  
L 160/200-240 P 90 H 75 cm

Sedia Tiffany Gonna cat. c lino froissé 011, 123, 010, 019.  
L 46 P 50 H 83/47 cm

Wallpaper WPT 560.

Infinity table with textured light knotted top, chalk white 121 metal frame.

L 160/200-240 W 90 H 75 cm

Tiffany Gonna chair in cat. c froissé linen 011, 123, 010, 019 fabric.  
W 46 D 50 H 83/47 cm

WPT 560 wallpaper.





## INFINITY

misure / size

rettangolare allungabile e fisso / extending and fixed rectangular

140 x 80

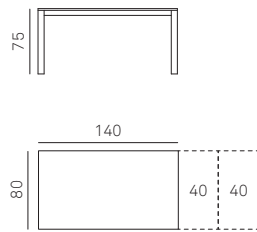

160 x 90

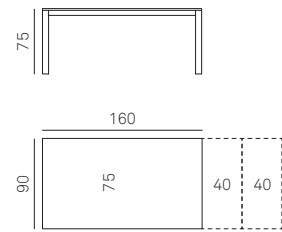

180 x 90

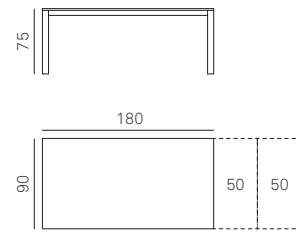

200 x 100

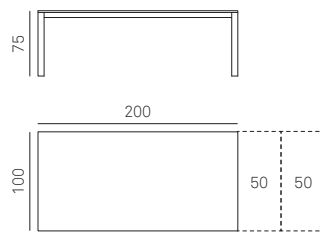

220 x 110

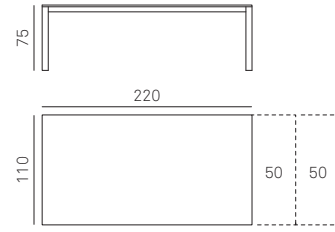

quadrato fisso / fixed square

100 x 100

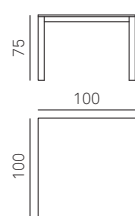

140 x 140

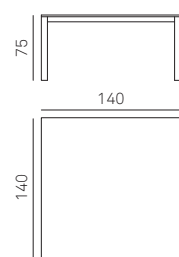

rettangolare a misura / rectangular to size

P/D 90/100/110

L/W 130 ÷ 170 (2 prolunghe / extensions da 40)

L/W 171 ÷ 190 (2 prolunghe / extensions da 50)

L/W 191 ÷ 220 (2 prolunghe / extensions da 50)

L/W 221 ÷ 250 (2 prolunghe / extensions da 50)

L/W 251 ÷ 280 (2 prolunghe / extensions da 50)

## FINITURE BASAMENTO / BASE FINISHES

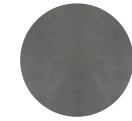

**DI SERIE / STANDARD**  
Finitura Peltro  
Pewter finish



**DI SERIE / STANDARD**  
Finitura Antracite  
Anthracite finish

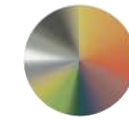

**colori laccati opachi a campionario**  
(vedi pagina 333)  
choice of matt lacquer colours from  
our range (see page 333)

## FINITURE PIANO / TOP FINISHES

MATERICO NODATO / KNOTTED TEXTURED



**MT-RNC**  
Nodato chiaro  
Light Knotted



**MT-RNS**  
Nodato scuro  
Dark knotted

MATERICO ESSENZA / TEXTURED WOOD



**MT-FO**  
Frassino Oriente  
Eastern Ash



**MT-RT**  
Rovere termocotto  
Heat-treated Oak

MATERICO PORO APERTO / OPEN PORE TEXTURED



**MT-PA BG**  
Bianco Gesso  
Chalk white



**MT-PA MP**  
Madreperla  
Mother of pearl

MATERICO OPACO / MATT TEXTURED



**MT-OC BG**  
Bianco Gesso  
Chalk white



**MT-OC MP**  
Madreperla  
Mother of pearl



**MT-OC AN**  
Antracite  
Anthracite

MATERICO / TEXTURED



**MT-CC**  
Cemento chiaro  
Light cement



**MT-CS**  
Cemento scuro  
Dark cement

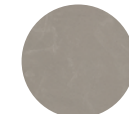

**MT-CV**  
Cemento Cava  
Cava cement

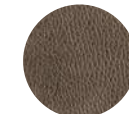

**MT-MB**  
Maya Bronze

LEGNO LACCATO PORO APERTO / OPEN PORE LACQUERED WOOD



**221 PA**  
Bianco Gesso  
Chalk white



**222 PA**  
Panna  
Cream



**224 PA**  
Madreperla  
Mother of pearl



**227 PA**  
Hot  
Hot grey



**230 PA**  
Grigio Piacenza  
Piacenza grey



**250 PA**  
Canapa  
Hemp

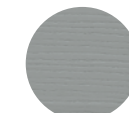

**252 PA**  
Pomice  
Pumice

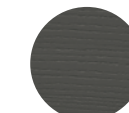

**260 PA**  
Antracite  
Anthracite

LACCATI / LACQUERS

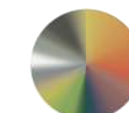

**colori laccati opachi a campionario**  
(vedi pagina 333)  
choice of matt lacquer colours  
from our range (see page 333)

# sedie

chairs

Le sedute rendono confortevole e accogliente la vita quotidiana. In ogni stanza della casa, dal living alla camera da letto, stand-alone o in gruppo, le sedie sono funzionali ma anche estremamente decorative.

Chairs add a touch of welcoming comfort to everyday life. In every corner of the home, from the living room to the bedroom, alone or in groups, chairs make a functional and, at the same time, extremely decorative feature.





## YORK

misure / size L/W 47 P/D 61 H 92/48 cm

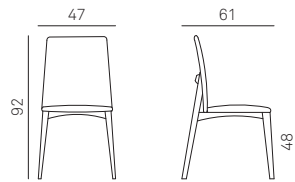

### FINITURE STRUTTURA / FRAME FINISHES

#### ESSENZE / WOOD FINISHES



**LGN-RT**  
Rovere termocotto  
Heat-treated Oak



**LGN-FO**  
Frassino oriente  
Eastern ash

#### LEGNO LACCATO PORO APERTO / OPEN-PORE LACQUERED WOOD



**221 PA**  
Bianco Gesso  
Chalk white



**222 PA**  
Panna  
Cream



**224 PA**  
Madreperla  
Mother of pearl



**227 PA**  
Hot  
Hot grey



**230 PA**  
Grigio Piacenza  
Piacenza grey



**250 PA**  
Canapa  
Hemp



**252 PA**  
Pomice  
Pumice

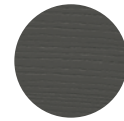

**260 PA**  
Antracite  
Anthracite

### RIVESTIMENTO / COVERING

Rivestimento in econabuk, ecopelle e pelle  
Eco-nubuck, eco-leather and leather upholstery



## YORK

Sedia York struttura  
legno rovere termocotto,  
rivestimento cat.b ecopelle  
vintage 106.  
L 47 P 61 H 92/48 cm

York chair with a heat-treated  
oak wood frame upholstered  
with cat. b vintage 106  
eco-leather.  
W 47 D 61 H 92/48 cm





# LOLITA

## Sedia Lolita

- 01. struttura legno frassino oriente, rivestimento cat. b ecopelle extrema 34.
  - 02. struttura legno laccato poro aperto madreperla 224, rivestimento cat. c tino froissè 20.
  - 03. struttura legno laccato poro aperto pomice 252, rivestimento cat. d nubes 09.
  - 04. struttura legno laccato poro aperto antracite 260, rivestimento cat. d nubes 09.
- L 51 P 56 H 79/47 cm

Wallpaper WPT 533.

## Lolita chair

- 01. eastern ash wood frame upholstered with cat. b extrema 34 eco-leather.
  - 02. open-pore mother of pearl 224 lacquered wood frame upholstered with cat. c froissè linen 20.
  - 03. open-pore pumice 252 lacquered wood frame upholstered with cat. d nubes 09.
  - 04. open-pore anthracite 260 lacquered wood frame upholstered with cat. d nubes 09.
- W 51 D 56 H 79/47 cm

WPT 533 wallpaper.



01.



02.



03.



04.



## LOLITA e LOLA

**Lolita** misure / size L/W 51 P/D 56 H 79/47 cm

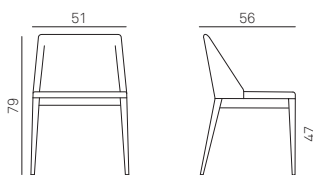

**Lola** misure / size L/W 55 P/D 53 H 81/47 cm

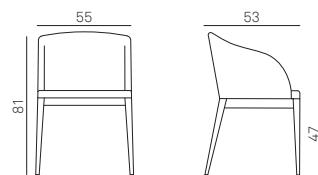

### FINITURE STRUTTURA / FRAME FINISHES

#### ESSENZE / WOOD FINISHES



**LGN-RT**  
Rovere termocotto  
Heat-treated Oak



**LGN-FO**  
Frassino orientale  
Eastern ash

#### LEGNO LACCATO PORO APERTO / OPEN-PORE LACQUERED WOOD



**221 PA**  
Bianco Gesso  
Chalk white



**222 PA**  
Panna  
Cream



**224 PA**  
Madreperla  
Mother of pearl



**227 PA**  
Hot  
Hot grey



**230 PA**  
Grigio Piacenza  
Piacenza grey



**250 PA**  
Canapa  
Hemp

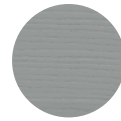

**252 PA**  
Pomice  
Pumice

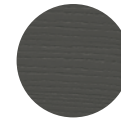

**260 PA**  
Antracite  
Anthracite

### RIVESTIMENTO / COVERING

**Econabuk, ecopelle e pelle**  
Eco-nubuck, eco-leather and leather upholstery



**Tessuti del campionario**  
Our range of fabrics



#### Sedia Lolita

- 01. struttura legno rovere termocotto, rivestimento cat. b hugo 04.
- 02. struttura legno rovere termocotto, rivestimento cat. b ecopelle vintage 102.
- 03. struttura legno rovere termocotto, rivestimento cat. b ecopelle vintage 107.

#### Lolita chair

- 01. heat-treated oak wood frame upholstered with cat. b hugo 04 fabric.
  - 02. heat-treated oak wood frame upholstered with cat. b vintage 102 eco-leather.
  - 03. heat-treated oak wood frame upholstered with cat. b vintage 107 eco-leather.
- W 51 D 56 H 79/47 cm





Sedia Lola struttura legno rovere termocotto, rivestimento cat. d nubes 10. L 55 P 53 H 81/47 cm

Lola chair with heat-treated oak wood frame upholstered with cat. d nubes 10 fabric. W 55 D 53 H 81/47 cm

Sedia Lola  
01. struttura legno rovere termocotto, rivestimento cat. d nubes 07.  
02. struttura legno rovere termocotto, rivestimento cat. d nubes 09.  
03. struttura legno rovere termocotto, rivestimento cat. c lino froissè 100. L 55 P 53 H 81/47 cm

Wallpaper WPT535.



LOLA

01.

02.

03.

Lola chair  
01. heat-treated oak wood frame upholstered with cat. d nubes 07 fabric.  
02. heat-treated oak wood frame upholstered with cat. d nubes 09 fabric.  
03. heat-treated oak wood frame upholstered with cat. c froissè linen 100 fabric. W 55 D 53 H 81/47 cm

WPT535 wallpaper.





Sedie Bea struttura legno rovere termocotto.  
L 42 P 53 H 78/44 cm

Bea chairs with a heat-treated oak wood  
frame.  
W 42 D 53 H 78/44 cm

## BEA

misure / size L/W 42 P/D 53 H 78/44 cm

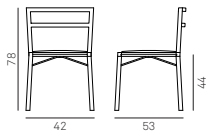

### FINITURE STRUTTURA / FRAME FINISHES

#### ESSENZE / WOOD FINISHES

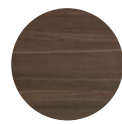

**LGN-RT**  
Rovere termocotto  
Heat-treated Oak

#### LEGNO LACCATO PORO APERTO / OPEN-PORE LACQUERED WOOD



**221 PA**  
Bianco Gesso  
Chalk white



**222 PA**  
Panna  
Cream



**224 PA**  
Madreperla  
Mother of pearl



**227 PA**  
Hot  
Hot grey



**230 PA**  
Grigio Piacenza  
Piacenza grey



**250 PA**  
Canapa  
Hemp

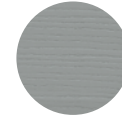

**252 PA**  
Pomice  
Pumice

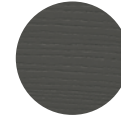

**260 PA**  
Antracite  
Anthracite





## TIME

misure / size L/W 43 P/D 52 H 80/44 cm

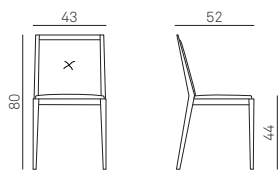

### FINITURE STRUTTURA / FRAME FINISHES

#### ESSENZE / WOOD FINISHES



**LGN-FO**  
Frassino Oriente  
Eastern Ash



**LGN-RT**  
Rovere termocotto  
Heat-treated Oak

#### LEGNO LACCATO PORO APERTO / OPEN-PORE LACQUERED WOOD



**221 PA**  
Bianco Gesso  
Chalk white



**222 PA**  
Panna  
Cream



**224 PA**  
Madreperla  
Mother of pearl



**227 PA**  
Hot  
Hot grey



**230 PA**  
Grigio Piacenza  
Piacenza grey



**250 PA**  
Canapa  
Hemp

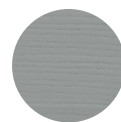

**252 PA**  
Pomice  
Pumice

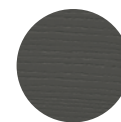

**260 PA**  
Antracite  
Anthracite

### RIVESTIMENTO / COVERING

Econabuk, ecopelle e pelle  
Eco-nubuck, eco-leather and leather upholstery



Tessuti del campionario  
Our range of fabrics



01. Sedie Time struttura legno rovere termocotto, rivestimento cat. b ecopelle vintage 107.  
02. Sedia Time struttura legno frassino oriente, rivestimento cat. b ecopelle vintage 107.  
L 43 P 52 H 80/44 cm

01. Time chairs with a heat-treated oak wood frame upholstered with cat. b vintage 107 eco-leather.  
02. Time chair with an eastern ash wood frame upholstered with cat. b vintage 107 eco-leather.  
W 43 D 52 H 80/44 cm

## TIME





# BETTY



Sedia Betty  
 01. cat. b ecopelle vintage 102.  
 02. cat. 1/one atom 34.  
 03. cat. b econabuk 12.  
 04. cat. b ecopelle 01.  
 05. cat. b econabuk 11.  
 06. cat. b ecopelle 15.  
 L 45 P 54 H 81/46 cm

Wallpaper WPT 535.  
 Wallpaper WPT 527.

Betty chair  
 01. cat. b vintage 102 eco-leather.  
 02. cat. 1/one atom 34.  
 03. cat. b eco-nubuck 12.  
 04. cat. b eco-leather 01.  
 05. cat. b eco-nubuck 11.  
 06. cat. b eco-leather 15.  
 W 45 D 54 H 81/46 cm

WPT 535 wallpaper.  
 WPT 527 wallpaper.

misure / size L/W 45 P/D 54 H 81/46

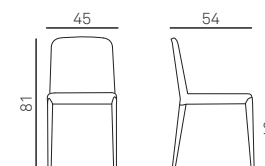

RIVESTIMENTO / COVERING

Econabuk, ecopelle e pelle  
 Eco-nubuck, eco-leather and leather upholstery







Sedia Skinny  
 01. cat. b ecopelle 16.  
 02. cat. b econabuk 02.  
 L 46 P 56 H 95/48 cm  
 Wallpaper WPT 512.

Skinny chair  
 01. cat. b eco-leather 16.  
 02. cat. b eco-nubuck 02.  
 W 46 D 56 H 95/48 cm  
 WPT 512 wallpaper.

## SKINNY

misure / size L/W 46 P/D 56 H 95/48 cm

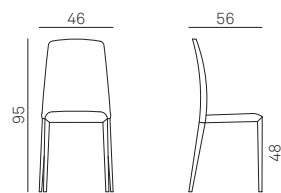

### RIVESTIMENTO / COVERING

Econabuk, ecopelle e pelle  
 Eco-nubuck, eco-leather and leather upholstery



## SKINNY

02.

01.



## TIFFANY

### Sedia Tiffany

- 01. struttura legno laccato poro aperto pomice 252, rivestimento cat. d nubes 09.
- 02. struttura legno laccato poro aperto madreperla 224, rivestimento cat. b hugo 04.
- 03. struttura legno laccato poro aperto madreperla 224, rivestimento cat. b ecopelle vintage. 107
- 04. struttura legno laccato poro aperto antracite 260, rivestimento cat. b ecopelle vintage 102.

L 46 P 50 H 83/47 cm  
Wallpaper WPT 511.

### Tiffany chair

- 01. open-pore pumice 252 lacquered wood frame upholstered with cat. d nubes 09 fabric.
- 02. open-pore mother of pearl 224 lacquered wood frame upholstered with cat. b hugo 04 fabric.
- 03. open-pore mother of pearl 224 lacquered wood frame upholstered with cat. b vintage eco-leather. 107
- 04. wooden frame in open-pore anthracite 260 lacquer upholstered with cat. b vintage 102 eco-leather.

W 46 D 50 H 83/47 cm

WPT 511 wallpaper.

01.

02.

03.

04.



Sedia Tiffany struttura legno laccato poro aperto antracite 260, rivestimento cat. b econabuk 07. >  
L 46 P 50 H 83/47 cm

Tiffany chair with an open-pore anthracite 260 lacquered wood frame upholstered with cat. b eco-nubuck 07.  
W 46 D 50 H 83/47 cm

## TIFFANY

misure / size L/W 46 P/D 50 H 83/47 cm

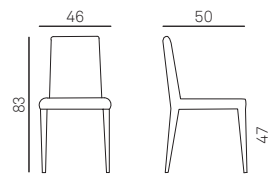

### FINITURE STRUTTURA / FRAME FINISHES

LEGNO LACCATO PORO APERTO / OPEN-PORE LACQUERED WOOD



**221 PA**  
Bianco Gesso  
Chalk white



**222 PA**  
Panna  
Cream



**224 PA**  
Madreperla  
Mother of pearl



**227 PA**  
Hot  
Hot grey



**230 PA**  
Grigio Piacenza  
Piacenza grey



**250 PA**  
Canapa  
Hemp

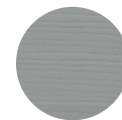

**252 PA**  
Pomice  
Pumice

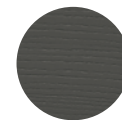

**260 PA**  
Antracite  
Anthracite

### RIVESTIMENTO / COVERING

Econabuk, ecopelle e pelle  
Eco-nubuck, eco-leather and leather upholstery



Tessuti del campionario  
Our range of fabrics







Sedia Tiffany Gonna in vari colori e tessuti.  
L 46 P 50 H 83/47 cm

Tiffany Gonna chair in various colours and fabrics.  
W 46 D 50 H 83/47 cm

## TIFFANY GONNA



### TIFFANY GONNA

misure / size L/W 46 P/D 50 H 83/47 cm

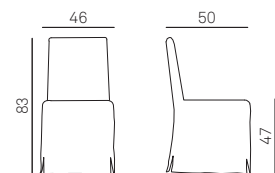

#### RIVESTIMENTO / COVERING

**Tessuti del campionario**  
Our range of fabrics

**Non disponibile in ecopelle,  
econabuk e pelle**  
Not available in eco-leather,  
eco-nubuck or leather





# madie

sideboards

Appartengono al passato e alla tradizione, ma oggi tornano con soluzioni originali e adatte a ogni tipo di spazio. Le madie aprono una nuova dimensione del design mentre piatti, bicchieri e stoviglie ritrovano casa.

A blast from the past, the sideboard is a part of tradition revived for today's homes with original solutions designed for spaces of all kinds. Sideboards bring a new dimension to contemporary design, while plates, glassware and crockery in general find a new home.







SIR

Madia Sir S04 struttura materico intreccio chiaro, elemento Sir materico rovere termocotto e basamento metallo antracite 160.  
L 216 P 51 H 90 cm

Sir S04 sideboard with a textured light Intreccio carcass, Sir element in textured heat-treated oak with an anthracite 160 metal base.  
W 216 D 51 H 90 cm





## SIR

Madia Sir S03 struttura materico intreccio chiaro, elemento Sir materico rovere termocotto e basamento metallo antracite 160.

L 216 P 51 H 66 cm

Collezione Natural Style S.

Sir S03 sideboard with a textured light Intreccio carcass, Sir element in textured heat-treated oak with an anthracite 160 metal base.

W 216 D 51 H 66 cm

Natural Style S collection.

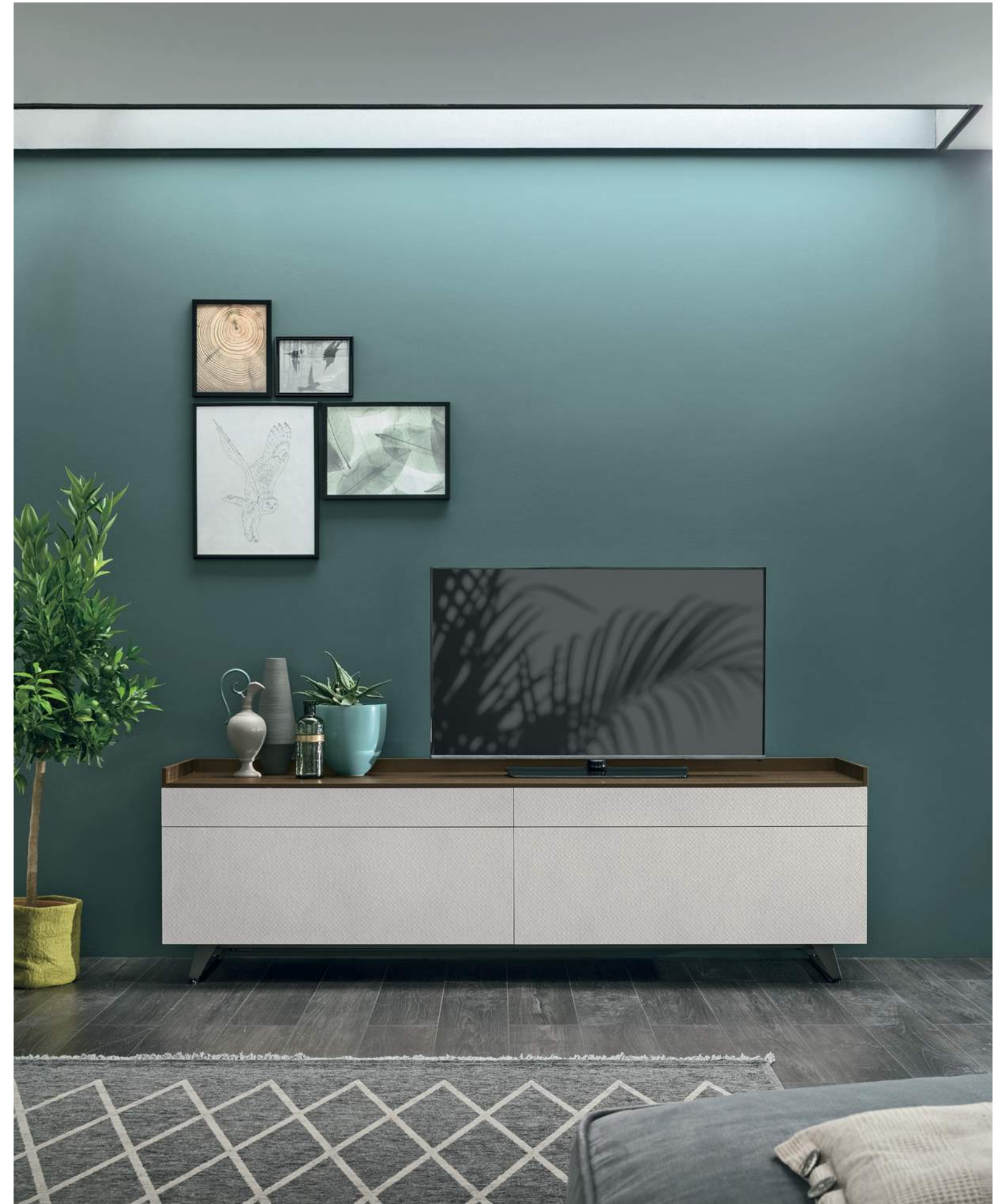



## SIR

Madia Sir S02 struttura laccato opaco salvia 159, elemento Sir legno rovere termocotto. L 270 P 40 H 54 cm

Tavolo Plinto piano vetro trasparente 320, struttura legno rovere termocotto e metallo antracite 160. L 240 P 110 H 75 cm

Sedie York struttura legno rovere termocotto, rivestimento cat. b econabuk 12. L 47 P 61 H 92/48 cm

Tappeto Black & White.

Sir S02 sideboard with a matt sage 159 lacquered carcass, Sir element in heat-treated oak wood. W 270 D 40 H 54 cm

Plinto table with a transparent 320 glass top, wooden heat-treated oak and anthracite 160 metal frame. L 240 W 110 H 75 cm

York chairs with a heat-treated oak wood frame upholstered with cat. b eco-nubuck 12. W 47 D 61 H 92/48 cm

Black & White rug.





## SIR

misure / size L/W 216 P/D 40 H 54 cm L/W 270 P/D 40 H 54 cm L/W 216 P/D 51 H 66 cm L/W 216 P/D 51 H 90 cm

S01

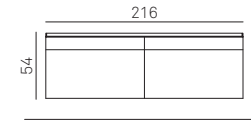

S02

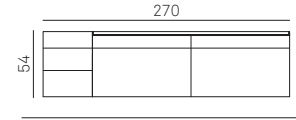

S03

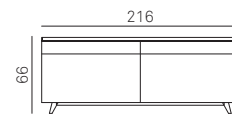

S04

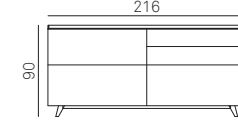

### FINITURE FRONTALI E ELEMENTO SIR / DOORS FINISHES AND SIR ELEMENT

#### ESSENZE / WOOD FINISHES



**LGN-FO**  
Frassino Oriente  
Eastern Ash



**LGN-RT**  
Rovere termocotto  
Heat-treated Oak

#### MATERICO ESSENZA / TEXTURED WOOD



**MT-FO**  
Frassino Oriente  
Eastern Ash



**MT-RT**  
Rovere termocotto  
Heat-treated Oak

#### MATERICO NODATO / KNOTTED TEXTURED



**MT-RNC**  
Nodato chiaro  
Light Knotted

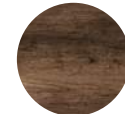

**MT-RNS**  
Nodato scuro  
Dark knotted

#### MATERICO / TEXTURED



**MT-CC**  
Cemento chiaro  
Light cement



**MT-CS**  
Cemento scuro  
Dark cement

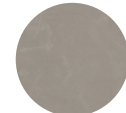

**MT-CV**  
Cemento Cava  
Cava cement

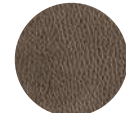

**MT-MB**  
Maya Bronze



**MT-INT C**  
Intreccio chiaro

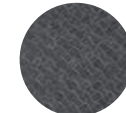

**MT-INT S**  
Intreccio scuro

**Elemento Sir non disponibile nelle finiture intreccio.**  
Sir element not available in Intreccio finishes.

#### MATERICO PORO APERTO / OPEN PORE TEXTURED



**MT-PA BG**  
Bianco Gesso  
Chalk white



**MT-PA MP**  
Madreperla  
Mother of pearl

#### MATERICO OPACO / MATT TEXTURED



**MT-OC BG**  
Bianco Gesso  
Chalk white



**MT-OC MP**  
Madreperla  
Mother of pearl



**MT-OC AN**  
Antracite  
Anthracite

#### LACCATI / LACQUERS

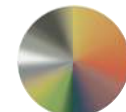

**colori laccati opachi e lucidi a campionario (vedi pagina 333)**  
choice of gloss and matt lacquer colours from our range (see page 333)

**Elemento Sir non disponibile nelle finiture in laccato lucido.**  
Sir element not available in gloss lacquered colours.

#### LEGNO LACCATO PORO APERTO / OPEN-PORE LACQUERED WOOD



**221 PA**  
Bianco Gesso  
Chalk white



**222 PA**  
Panna  
Cream



**224 PA**  
Madreperla  
Mother of pearl



**227 PA**  
Hot  
Hot grey



**230 PA**  
Grigio Piacenza  
Piacenza grey



**250 PA**  
Canapa  
Hemp

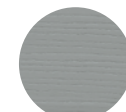

**252 PA**  
Pomice  
Pumice

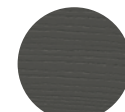

**260 PA**  
Antracite  
Anthracite

### FINITURE BASAMENTO / BASE FINISHES



**DI SERIE / STANDARD**  
Finitura Peltro  
Pewter finish



**DI SERIE / STANDARD**  
Finitura Antracite  
Anthracite finish

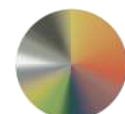

**colori laccati opachi a campionario (vedi pagina 333)**  
choice of matt lacquer colours from our range (see page 333)





a sinistra  
Madia Regolo R01 struttura laccato opaco  
zafferano 158, inserto materico nodato  
scuro e basamento metallo zafferano 158.  
L 108 P 40 H 147 cm

a destra  
Madia Regolo R02 struttura materico opaco  
madreperla, inserto materico nodato scuro.  
basamento metallo madreperla 124.  
L 108 P 40 H 147 cm

on the left  
Regolo R01 sideboard with a matt saffron  
158 lacquered carcass, textured dark  
knotted insert and saffron 158 metal base.  
W 108 D 40 H 147 cm

on the right  
Regolo R02 sideboard with a matt mother  
or pearl lacquered carcass, textured dark  
knotted insert. Mother of pearl 124 metal  
base.  
W 108 D 40 H 147 cm



## REGOLO







**REGOLO**

Madia Regolo R05 struttura materico opaco madreperla, inserto materico nodato scuro e basamento metallo madreperla 124. L 180 P 51 H 93,5 cm

Collezione Quadri Loft Style S.

Tappeto Frame.

Regolo R05 sideboard with a matt mother or pearl lacquered carcass, textured dark knotted insert and Mother or pearl 124 metal base. W 180 D 51 H 93.5 cm

Loft Style S Quadri collection.

Frame rug.





## REGOLO

Madie Regolo R03 struttura materico opaco bianco gesso, inserto materico opaco antracite.  
L 108 P 40 H 147,5 cm

Sedia Lola struttura legno rovere termocotto, rivestimento cat. c lino froissé 123.  
L 55 P 53 H 81/47 cm

Regolo R03 sideboards with a textured matt chalk white carcass and an textured anthracite matt insert.  
W 108 D 40 H 147,5 cm

Lola chair with a heat-treated oak frame upholstered with cat. c froissé linen 123 fabric.  
W 55 D 53 H 81/47 cm







## REGOLO

Madia Regolo R06 struttura materico opaco bianco gesso, inserto materico frassino orientale e basamento metallo antracite 160. L 216 P 51 H 93,5 cm

Regolo R06 sideboard with a textured matt chalk white carcass, a textured eastern ash insert and an anthracite 160 metal base. W 216 D 51 H 93.5 cm





# REGOLO

misure / size

P/D 40 cm

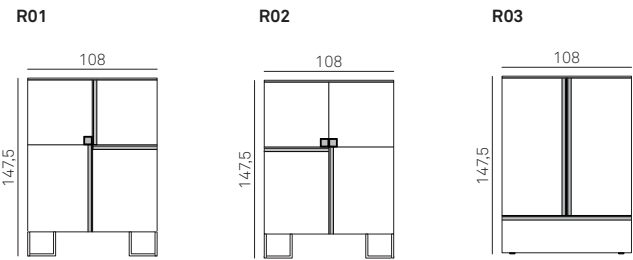

P/D 51 cm

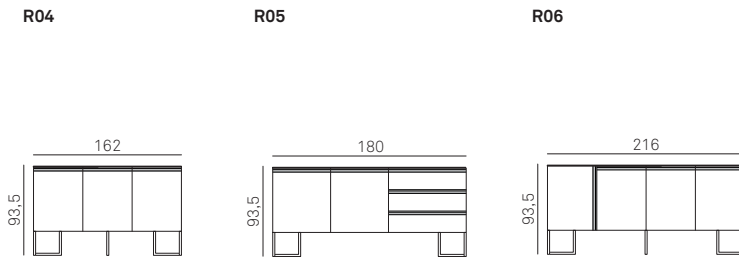

## FINITURE STRUTTURA / STRUCTURE FINISHES

ESSENZE / WOOD FINISHES



MATERICO ESSENZA / TEXTURED MATERIC



MATERICO NODATO / KNOTTED TEXTURED

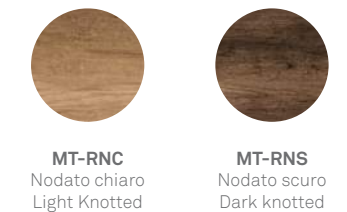

MATERICO OPACO / MATT MATERIC

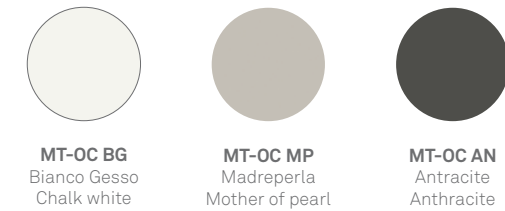

MATERICO PORO APERTO / OPEN PORE MATERIC



MATERICO / TEXTURED



LACCATI / LACQUERS

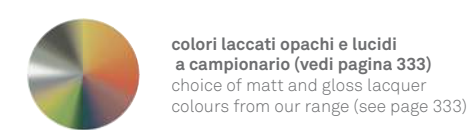

LEGNO LACCATO PORO APERTO / OPEN-PORE LACQUERED WOOD

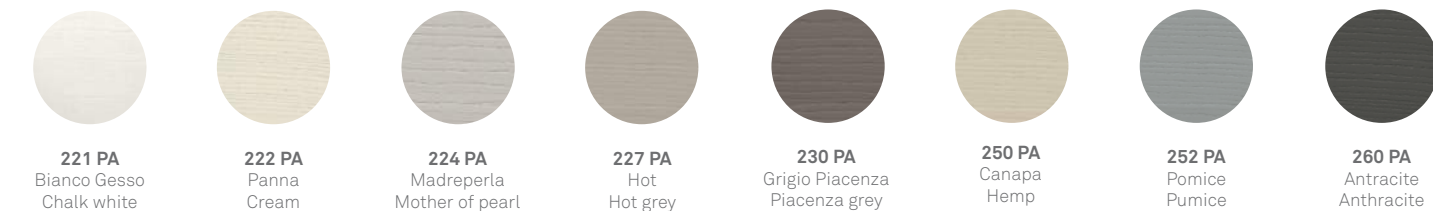

## FINITURE MANIGLIA REGOLO / REGOLO HANDLE FINISHES

MATERICO ESSENZA / TEXTURED WOOD



MATERICO NODATO / KNOTTED TEXTURED

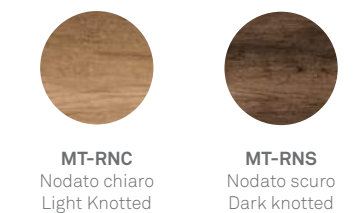

MATERICO / TEXTURED



MATERICO OPACO / MATT TEXTURED

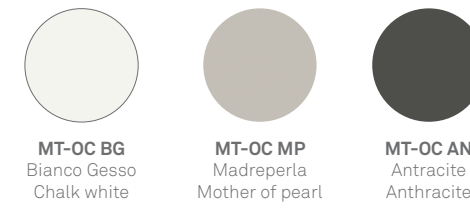

MATERICO PORO APERTO / OPEN PORE TEXTURED



LACCATI / LACQUERS

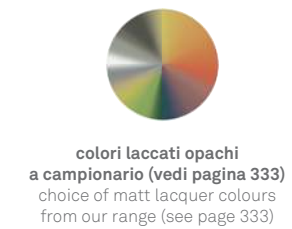

METALLO LACCATO / LACQUERED METAL



LEGNO LACCATO PORO APERTO / OPEN-PORE LACQUERED WOOD



## FINITURE BASAMENTO / BASE FINISHES

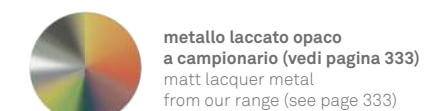





## REMIX

Madia Remix X02 struttura materico opaco madreperla, materico nodato chiaro e metallo antracite 160.  
L 162 P 51 H 85,5 cm

Collezione Quadri Natural Style M.

Remix X02 sideboard with a matt mother of pearl, textured light knotted and anthracite metal 160 carcass.  
W 162 D 51 H 85.5 cm

Natural Style M Quadri collection.







**REMIX**

Madia Remix X01 struttura laccato opaco  
 carta da zucchero 155 e salvia 159.  
 Basamento metallo antracite 160.  
 L 108 P 40 H 129,5 cm

Remix X01 sideboard with a matt blue grey 155  
 and sage 159 lacquered carcass. Anthracite  
 160 metal base.  
 W 108 D 40 H 129.5 cm





L'angolo tagliato è il tratto distintivo di Remix: l'anta asimmetrica e l'accostamento di materiali diversi conferisce originalità ed equilibrio alla composizione.

The angled door is a distinctive feature of the Remix model: the asymmetric door and the combination of different finishes give the arrangement an original yet balanced appeal.

## REMIX

Madia Remix X05 struttura materico cemento chiaro, elemento Sir legno frassino orientale e metallo antracite 160. L 180 P 51 H 84 cm

Collezione Quadri Elegance Style M.

Remix X05 sideboard with a light textured cement carcass, Sir element in eastern ash wood and anthracite 160 metal. W 180 D 51 H 84 cm

Elegance Style M Quadri collection.





# REMIX

misure / size

P/D 40 cm

X01

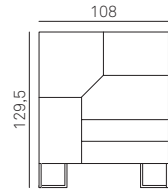

P/D 51 cm  
Esempi destra / Right-hand examples

X02

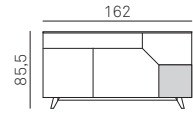

X03

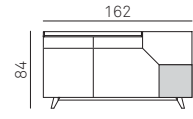

X04

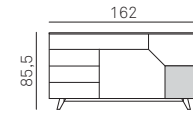

X05

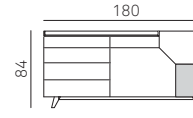
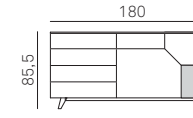
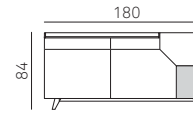
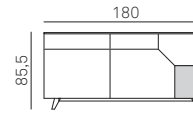
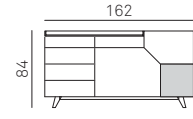

## FINITURE FRONTALI / DOORS FINISHES

ESSENZE / WOOD FINISHES



**LGN-FO**  
Frassino Oriente  
Eastern Ash



**LGN-RT**  
Rovere termocotto  
Heat-treated Oak

MATERICO ESSENZA / WOOD TEXTURE



**MT-FO**  
Frassino Oriente  
Eastern Ash



**MT-RT**  
Rovere termocotto  
Heat-treated Oak

MATERICO NODATO / KNOTTED TEXTURED



**MT-RNC**  
Nodato chiaro  
Light Knotted



**MT-RNS**  
Nodato scuro  
Dark knotted

MATERICO OPACO / MATT TEXTURED

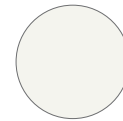

**MT-OC BG**  
Bianco Gesso  
Chalk white



**MT-OC MP**  
Madreperla  
Mother of pearl

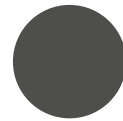

**MT-OC AN**  
Antracite  
Anthracite

MATERICO PORO APERTO / OPEN PORE MATERIC



**MT-PA BG**  
Bianco Gesso  
Chalk white



**MT-PA MP**  
Madreperla  
Mother of pearl

MATERICO / TEXTURED



**MT-CC**  
Cemento chiaro  
Light cement



**MT-CS**  
Cemento scuro  
Dark cement



**MT-CV**  
Cemento cava  
Cava cement

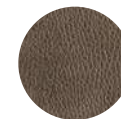

**MT-MB**  
Maya Bronze



**MT-INT C**  
Intreccio chiaro

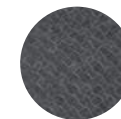

**MT-INT S**  
Intreccio scuro

LACCATI / LACQUERS

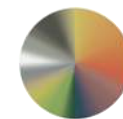

colori laccati opachi e lucidi  
a campionario (vedi pagina 333)  
choice of matt and gloss lacquer  
colours from our range (see page 333)

LEGNO LACCATO PORO APERTO / OPEN-PORE LACQUERED WOOD



**221 PA**  
Bianco Gesso  
Chalk white



**222 PA**  
Panna  
Cream



**224 PA**  
Madreperla  
Mother of pearl



**227 PA**  
Hot  
Hot grey



**230 PA**  
Grigio Piacenza  
Piacenza grey



**250 PA**  
Canapa  
Hemp

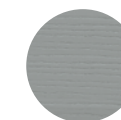

**252 PA**  
Pomice  
Pumice

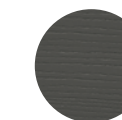

**260 PA**  
Antracite  
Anthracite

## FINITURE ELEMENTO SIR / SIR ELEMENT FINISHES AND

ESSENZE / WOOD FINISHES



**LGN-FO**  
Frassino Oriente  
Eastern Ash



**LGN-RT**  
Rovere termocotto  
Heat-treated Oak

MATERICO ESSENZA / TEXTURED WOOD



**MT-FO**  
Frassino Oriente  
Eastern Ash



**MT-RT**  
Rovere termocotto  
Heat-treated Oak

MATERICO NODATO / KNOTTED TEXTURED



**MT-RNC**  
Nodato chiaro  
Light Knotted



**MT-RNS**  
Nodato scuro  
Dark knotted

MATERICO PORO APERTO / OPEN PORE TEXTURED



**MT-PA BG**  
Bianco Gesso  
Chalk white



**MT-PA MP**  
Madreperla  
Mother of pearl

MATERICO / TEXTURED



**MT-CC**  
Cemento chiaro  
Light cement



**MT-CS**  
Cemento scuro  
Dark cement

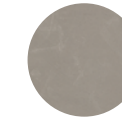

**MT-CV**  
Cemento Cava  
Cava cement



**MT-MB**  
Maya Bronze

MATERICO OPACO / MATT TEXTURED



**MT-OC BG**  
Bianco Gesso  
Chalk white



**MT-OC MP**  
Madreperla  
Mother of pearl



**MT-OC AN**  
Antracite  
Anthracite

LACCATI / LACQUERS

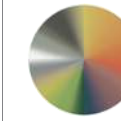

colori laccati opachi e lucidi a  
campionario (vedi pagina 333)  
choice of gloss and matt lacquer  
colours from our range (see page 333)

Elemento Sir disponibile solo in laccato opaco.  
Elemento Sir disponibile solo in laccato opaco.

LEGNO LACCATO PORO APERTO / OPEN-PORE LACQUERED WOOD



**221 PA**  
Bianco Gesso  
Chalk white



**222 PA**  
Panna  
Cream



**224 PA**  
Madreperla  
Mother of pearl

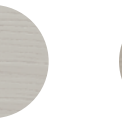

**227 PA**  
Hot  
Hot grey



**230 PA**  
Grigio Piacenza  
Piacenza grey



**250 PA**  
Canapa  
Hemp



**252 PA**  
Pomice  
Pumice

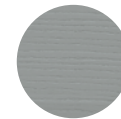

**260 PA**  
Antracite  
Anthracite

## FINITURE BASAMENTO / BASE FINISHES



**DI SERIE / STANDARD**  
Finitura Peltro  
Pewter finish



**DI SERIE / STANDARD**  
Finitura Antracite  
Anthracite finish

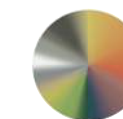

colori laccati opachi a campionario  
(vedi pagina 333)  
choice of matt lacquer colours  
from our range (see page 333)



METROPOLIS







< METROPOLIS

**Pagina precedente**  
 Madia Metropolis A03 materico intreccio  
 chiaro e metallo antracite 160.  
 L 180 P 51 H 85,5 cm  
 Collezione Quadri Elegance Style S.  
 Tappeto Dots.

**Preceding page**  
 Metropolis A03 sideboard in textured light  
 Intreccio and anthracite 160 metal.  
 W 180 D 51 H 85,5 cm  
 Elegance Style S Quadri collection.  
 Dots rug.







**METROPOLIS**

Madia Metropolis B01 struttura materico rovere termocotto, basamento metallo antracite 160.  
L 180 P 51 H 85,5 cm  
Wallpaper WPT 513.

Metropolis B01 sideboard with a textured heat-treated oak carcass and an anthracite 160 metal base.  
W 180 D 51 H 85.5 cm  
WPT 513 wallpaper.

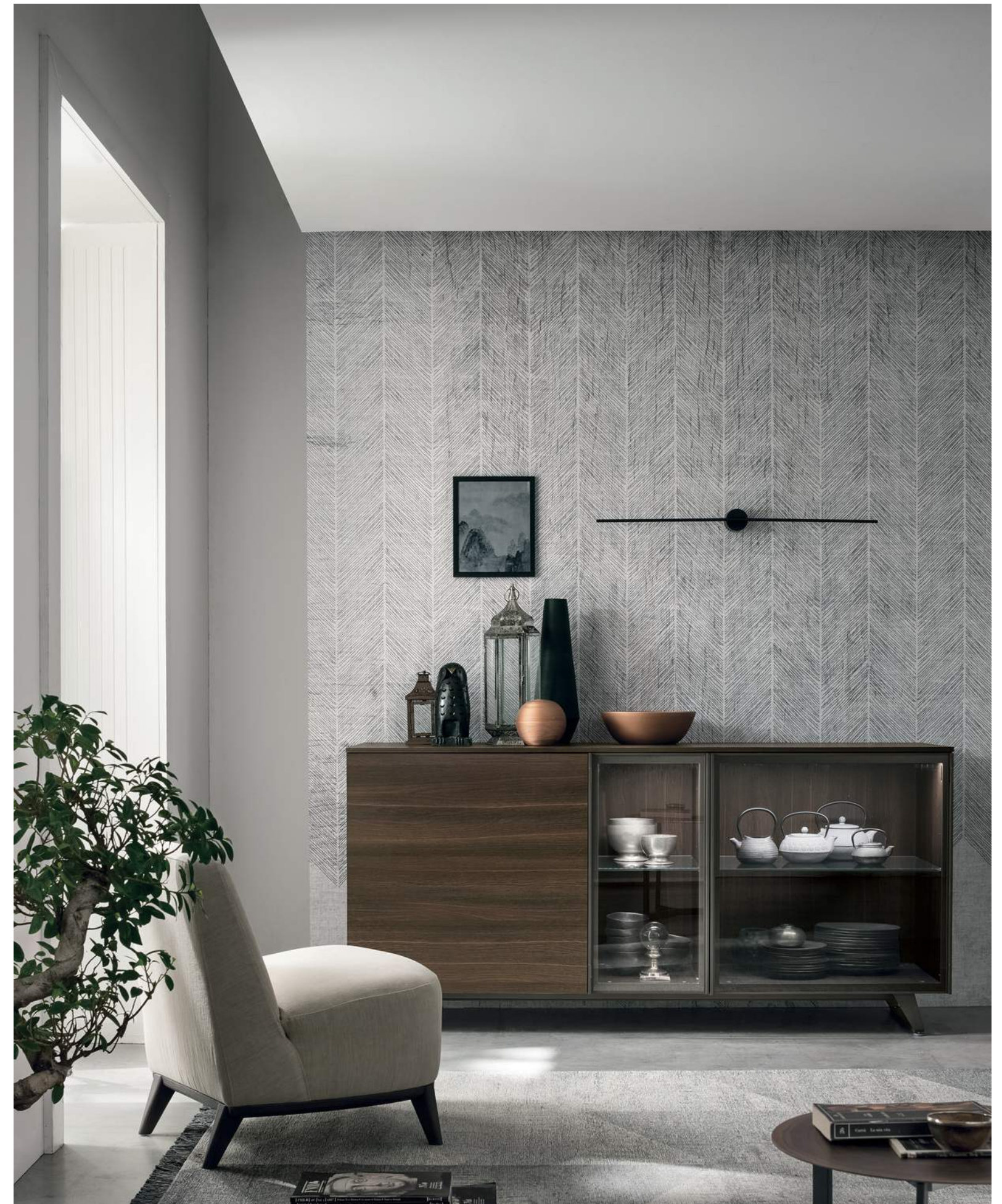



## METROPOLIS

Madia Metropolis struttura materico rovere termocotto, basamento metallo antracite 160. L 108 H 157,5 P 40 cm

Metropolis sideboard with a textured heat-treated oak carcass and an anthracite 160 metal base. W 108 H 157.5 D 40 cm



## METROPOLIS

Madia Metropolis A06 struttura materico rovere termocotto, basamento metallo antracite 160. L 216 P 51 H 85,5 cm

Collezione Quadri Contemporary Style L.

Tappeto Gradient.

Metropolis A06 sideboard with a textured heat-treated oak carcass and an anthracite 160 metal base. W 216 D 51 H 85.5 cm

Contemporary Style L Quadri collection.

Gradient rug.







## METROPOLIS

Madia Metropolis A02 struttura laccato opaco salvia 159, basamento metallo antracite 160. L 216 P 51 H 85,5 cm

Collezione Quadri Contemporary Style S.

Metropolis A02 sideboard with a matt sage 159 lacquered carcass and an anthracite 160 metal base.

W 216 D 51 H 85.5 cm

Contemporary Style S Quadri collection.





**METROPOLIS**

Madia Metropolis A04 struttura  
laccato opaco carta da zucchero 155,  
basamento metallo antracite 160.  
L 216 P 51 H 85,5 cm

Wallpaper WPT 550.

Metropolis A04 sideboard with a  
matt blue grey 155 carcass and an  
anthracite 160 metal base.

W 216 D 51 H 85,5 cm

WPT 550 wallpaper.



## METROPOLIS

Madia Metropolis C01 materico opaco madreperla e materico frassino orientale, basamento metallo antracite 160. L 144 P 51 H 121,5 cm

Metropolis C01 sideboard in matt mother of pearl and textured eastern ash, anthracite 160 metal base. W 144 D 51 H 121.5 cm



## METROPOLIS

Madia Metropolis A03 struttura laccato opaco bianco gesso 121, basamento metallo antracite 160. L 216 P 51 H 85,5 cm

Collezione Quadri Elegance Style M.

Metropolis A03 sideboard with a matt chalk white 121 lacquered carcass and anthracite 160 metal base. W 216 D 51 H 85.5 cm

Elegance Style M Quadri collection.







## METROPOLIS

Madia Metropolis A01 struttura laccato opaco bianco gesso 121 e smoke 128. Basamento metallo antracite 160. L 216 P 51 H 85 cm

Tappeto Frame.

Wallpaper WPT 512.

Metropolis A01 sideboard with a matt chalk white 121 and smoke 128 carcass. Anthracite 160 metal base. W 216 D 51 H 85 cm

Frame rug.

WPT 512 wallpaper.



## METROPOLIS

misure / size

P / D 51 cm

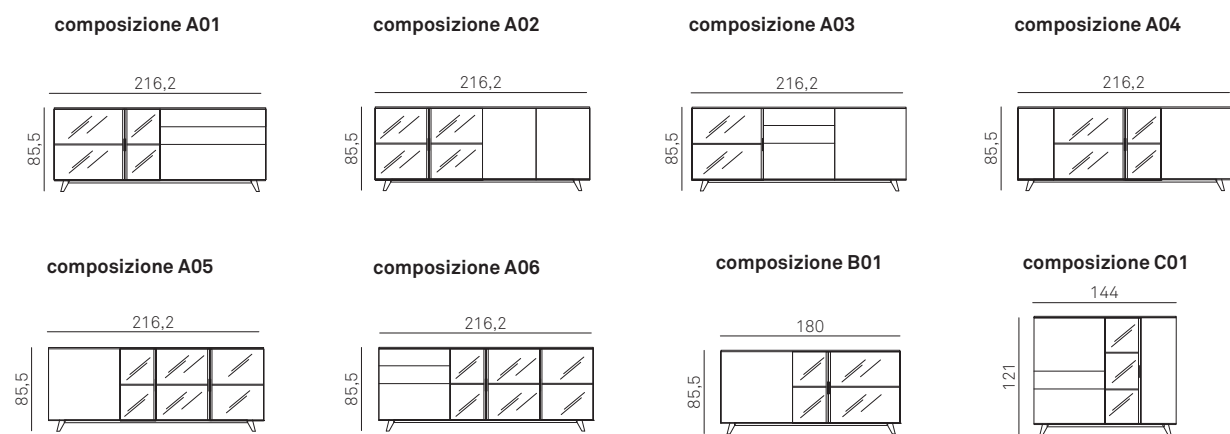

P / D 40 cm

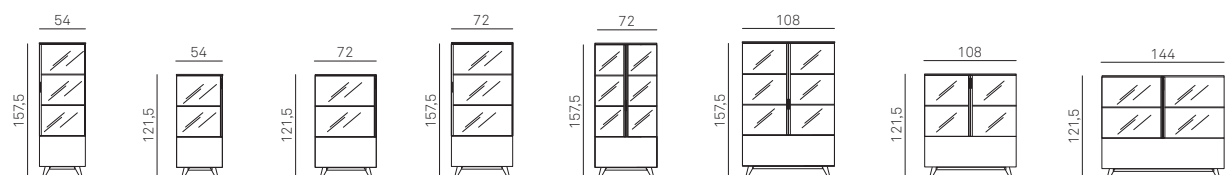

P / D 40 - 51 cm



## FINITURE STRUTTURA / CARCASS FINISHES

ESSENZE / WOOD FINISHES

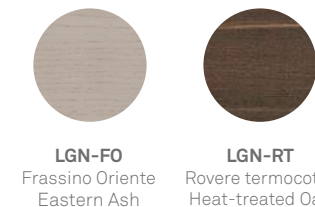

MATERICO ESSENZA / TEXTURED WOOD

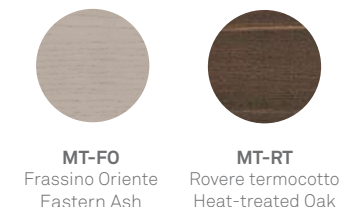

MATERICO NODATO / KNOTTED TEXTURED

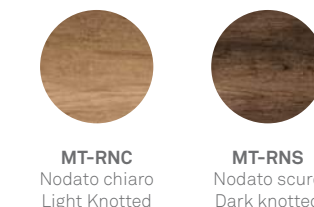

MATERICO OPACO / MATT TEXTURED

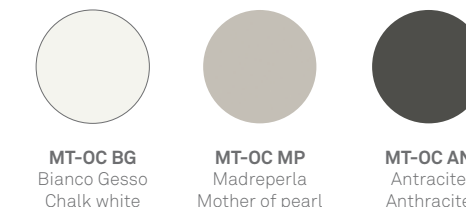

MATERICO / TEXTURED

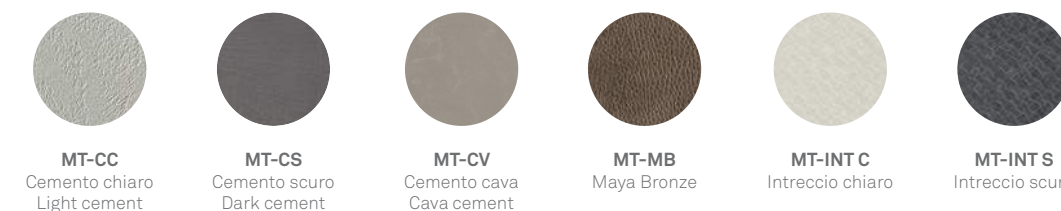

MATERICO PORO APERTO / OPEN PORE TEXTURED



LEGNO LACCATO PORO APERTO / OPEN-PORE LACQUERED WOOD



LACCATI / LACQUERS

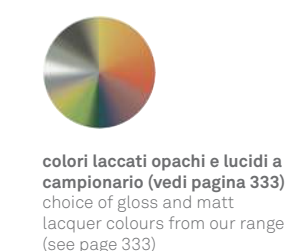

## FINITURE ANTA METROPOLIS / METROPOLIS DOOR FINISHES



## FINITURE BASAMENTO / BASE FINISHES

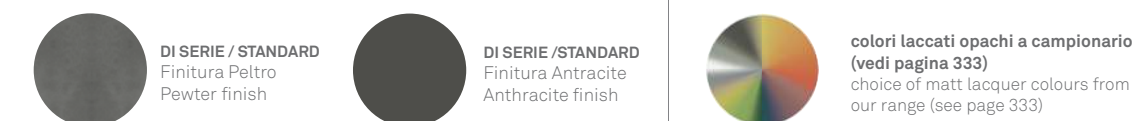







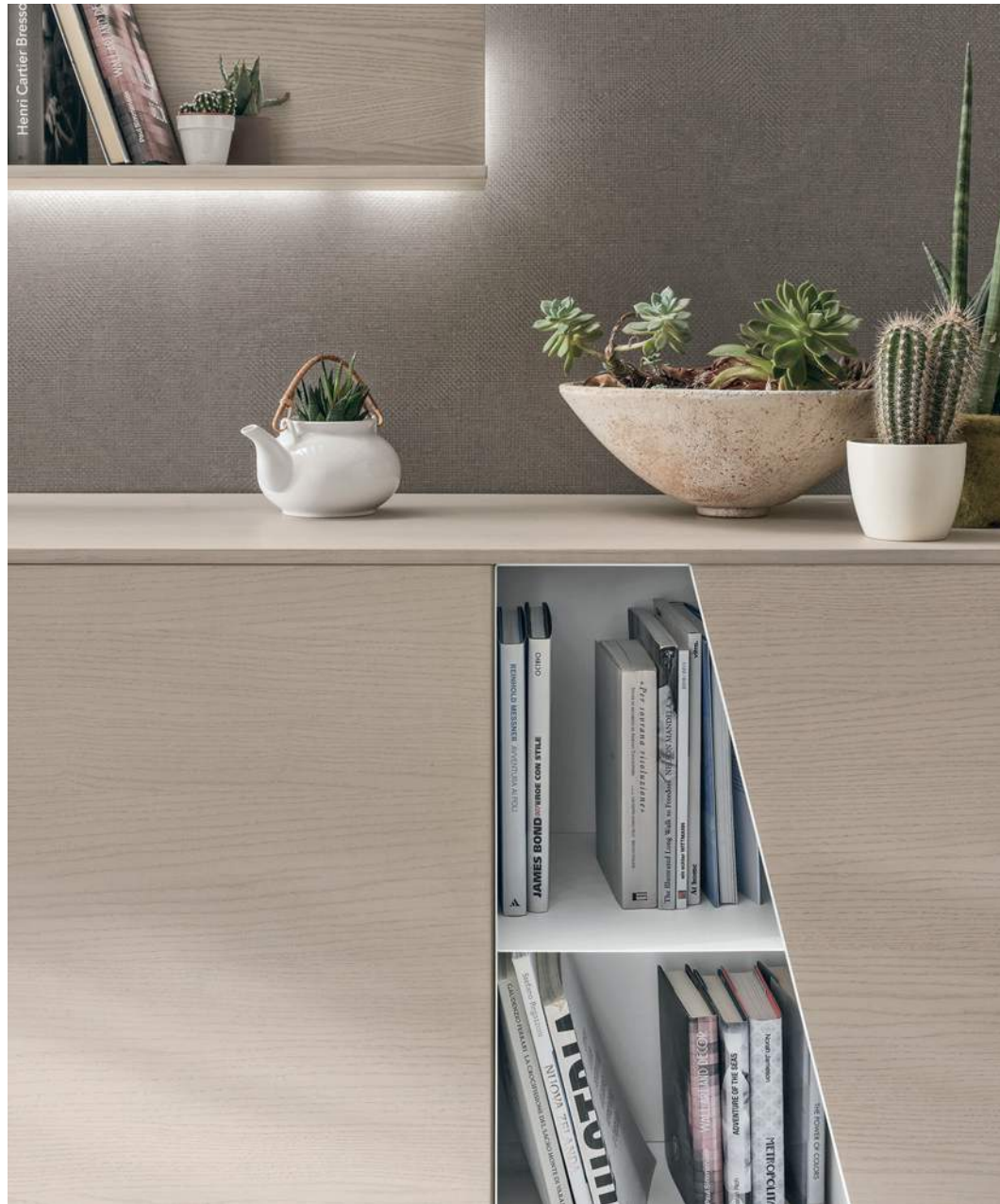

## METROPOLIS

**Pagina precedente**  
 Madia Diagonal Var. A struttura materico frassino orientale, metallo bianco gesso 121.  
 L 219 P 51 H 85,5 cm

Mensole Ring materico frassino orientale, metallo bianco gesso 121.  
 L 144 P 26 H 27 cm

Poltroncina Loft struttura legno frassino orientale, rivestimento cat. c linara 31.  
 L 59 P 70 H 64 cm

Pouf Guccino rivestimento cat. c linara 30 e laccato opaco bianco gesso 121.  
 Ø 40 H 53 cm

Tappeto Diagonal.

**Preceding page**  
 Diagonal sideboard Var. Textured eastern ash and chalk white 121 metal carcass.  
 W 219 D 51 H 85.5 cm

Ring shelves in textured eastern ash and chalk white 121 metal.  
 L 144 D 26 H 27 cm

Loft armchair with an eastern ash wood frame upholstered with cat. c linara 31 fabric.  
 W 59 D 70 H 64 cm

Guccino pouf upholstered with cat. c linara 30 fabric and mat chalk white 121 lacquered.  
 Ø 40 H 53 cm

Diagonal rug.







## DIAGONAL

Madia Diagonal Var. B struttura materico opaco bianco gesso, materico frassino oriente, metallo smoke 128.  
L 219 P 51 H 85,5 cm

Poltroncina Loft struttura legno rovere termocotto, rivestimento cat. b econabuk 07.  
L 59 P 70 H 64 cm

Diagonal sideboard Var. B in textured matt chalk white, textured eastern ash and smoke 128 metal.  
W 219 D 51 H 85.5 cm

Loft armchair with a heat-treated oak wood frame upholstered with cat. b eco-nubuck 07.  
W 59 D 70 H 64 cm



Il taglio diagonale crea un vano a giorno per mettere gli oggetti in bella vista. La madia è ricca di soluzioni pratiche per contenere ed esporre.

The diagonal cut-out creates open shelving for showcasing favourite objects. The sideboard features a wealth of practical storage and display solutions.

## DIAGONAL

Madia Diagonal Var. A struttura materico rovere termocotto, vano a giorno metallo madreperla 124 e basamento metallo antracite 160.  
L 219 P 51 H 85,5 cm

Sedia Lola struttura legno rovere termocotto, rivestimento cat. b ecopelle vintage 107.  
L 55 P 53 H 81/47 cm

Diagonal sideboard Var. A with a textured heat-treated oak carcass, an open compartment in mother of pearl 124 metal and an anthracite 160 metal base.  
W 219 D 51 H 85.5 cm

Lola chair with a heat-treated oak wood frame upholstered with cat. b vintage 107 eco-leather.  
W 55 D 53 H 81/47 cm





## DIAGONAL



Struttura laccato opaco madreperla 124, materico frassino oriente e vani a giorno metallo antracite 160. Matt mother of pearl 124 and textured eastern ash carcass, anthracite 160 metal open compartments.



Struttura materico rovere termocotto, vani a giorno metallo madreperla 124. Textured heat-treated oak carcass and mother of pearl 124 metal open compartments.



Struttura laccato opaco bianco gesso 121, vani a giorno e basamento metallo bordeaux 156. Matt chalk white 121 lacquered carcass, burgundy 156 metal open compartments and base.



Struttura laccato opaco smoke 128, vani a giorno e basamento metallo pomice 152. Matt smoke 128 lacquered carcass, pumice 152 metal open compartments and base.

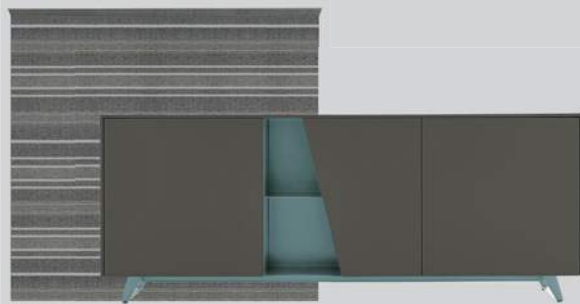

Struttura laccato opaco antracite 160, vani a giorno e basamento metallo salvia 159. Pannello Krea grafica 452. Matt anthracite 160 lacquered carcass, sage 159 metal open compartments and base. Graphic 452 Krea panel.



Struttura laccato opaco carta da zucchero 155, vani a giorno e basamento metallo antracite 160. Pannello Krea grafica 412. Matt blue grey 155 lacquered carcass, anthracite 160 metal open compartments and base. Graphic 412 Krea panel.

## DIAGONAL

Madia Diagonal struttura materico opaco bianco gesso e materico nodato scuro, vani a giorno metallo antracite 160. L 183 P 51 H 111,5 cm

Diagonal sideboard with textured matt chalk white and textured dark knotted carcass. Anthracite 160 metal open compartments. W 183 D 51 H 111,5 cm







## DIAGONAL

Madia Diagonal Var.B struttura materico opaco bianco gesso e materico nodato scuro. Vani a giorno e basamento metallo antracite 160.  
L 219 P 51 H 85,5 cm

Pannello Krea grafica 411.  
L 144 P 22 H 144 cm

Collezione Quadri Colors Style XS.

Tappeto Stripes.

Diagonal sideboard Var. B with textured matt chalk white and textured dark knotted carcass. Anthracite 160 metal open compartments and base.  
W 219 D 51 H 85.5 cm

Graphic 411 Krea panel.  
W 144 D 22 H 144 cm

Colors Style XS Quadri collection.

Stripes rug.



# KREA

boiserie Krea / Krea wall panelling misure / size L/W 144 P/D 22 H 144 cm

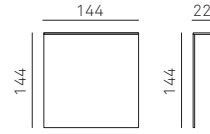

## FINITURE BOISERIE / FINISHES WALL PANELLING

MATERICO ESSENZA /  
WOOD TEXTURE



**MT-FO**  
Frassino Oriente  
Eastern Ash



**MT-RT**  
Rovere termocotto  
Heat-treated Oak



**MT-RNC**  
Nodato chiaro  
Light Knotted



**MT-RNS**  
Nodato scuro  
Dark knotted



**MT-OC BG**  
Bianco Gesso  
Chalk white



**MT-OC MP**  
Madreperla  
Mother of pearl



**MT-OC AN**  
Antracite  
Anthracite



**MT-PA BG**  
Bianco Gesso  
Chalk white



**MT-PA MP**  
Madreperla  
Mother of pearl

MATERICO /  
TEXTURED



**MT-CC**  
Cemento chiaro  
Light cement



**MT-CS**  
Cemento scuro  
Dark cement

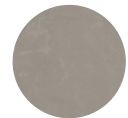

**MT-CV**  
Cemento cava  
Cava cement

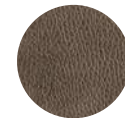

**MT-MB**  
Maya Bronze



**MT-INT C**  
Intreccio chiaro

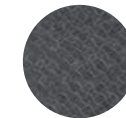

**MT-INT S**  
Intreccio scuro

FINITURE BOISERIE E MENSOLA/  
SHELF FINISHES AND WALL PANELLING  
LACCATI / LACQUERS

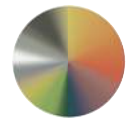

colori laccati opachi  
a campionario (vedi pagina 333)  
choice of matt lacquer colours  
from our range (see page 333)

## GRAFICHE PER BOISERIE KREA / GRAPHIC DESIGNS FOR KREA WALL PANELLING

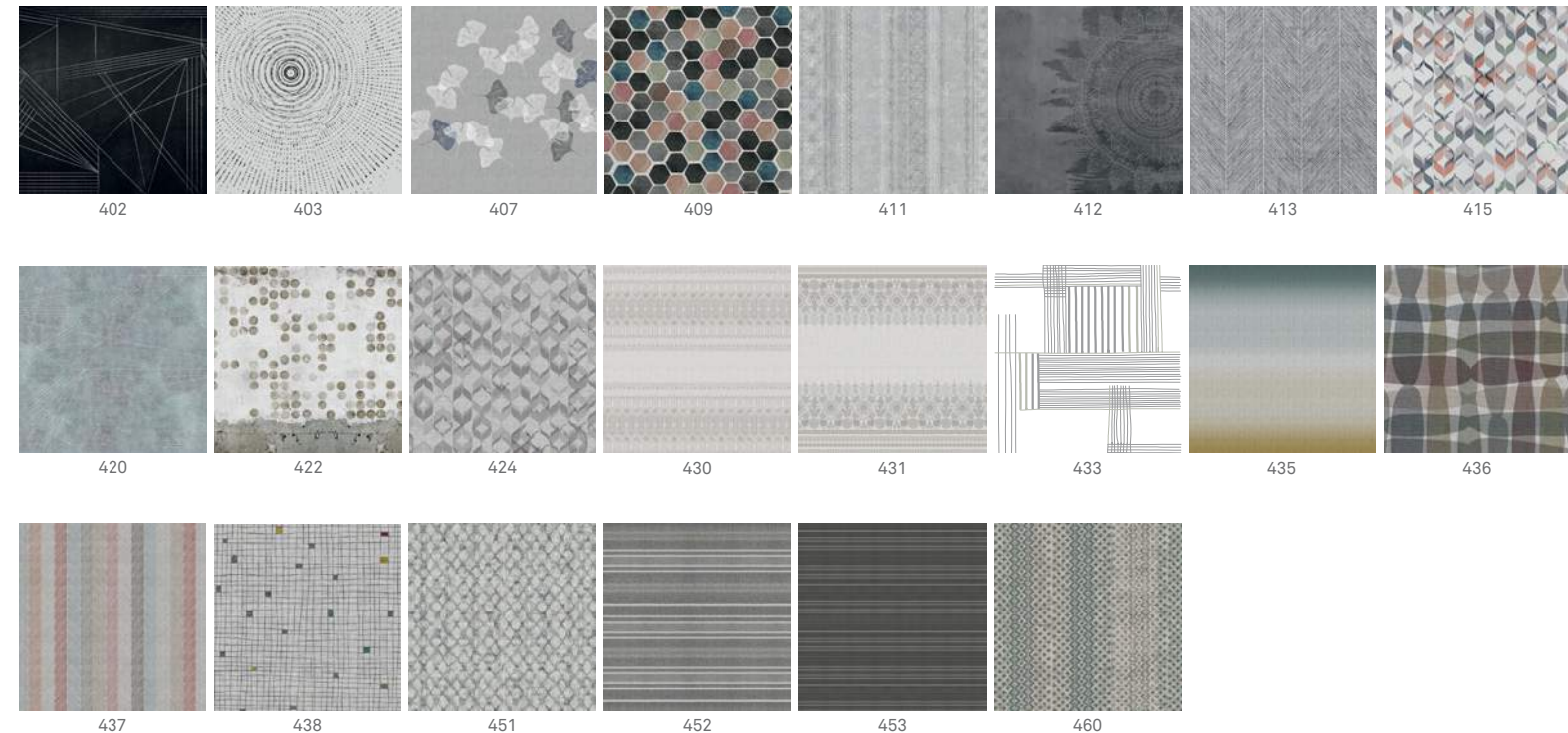



## DIAGONAL

misure / size

P/D 51 cm

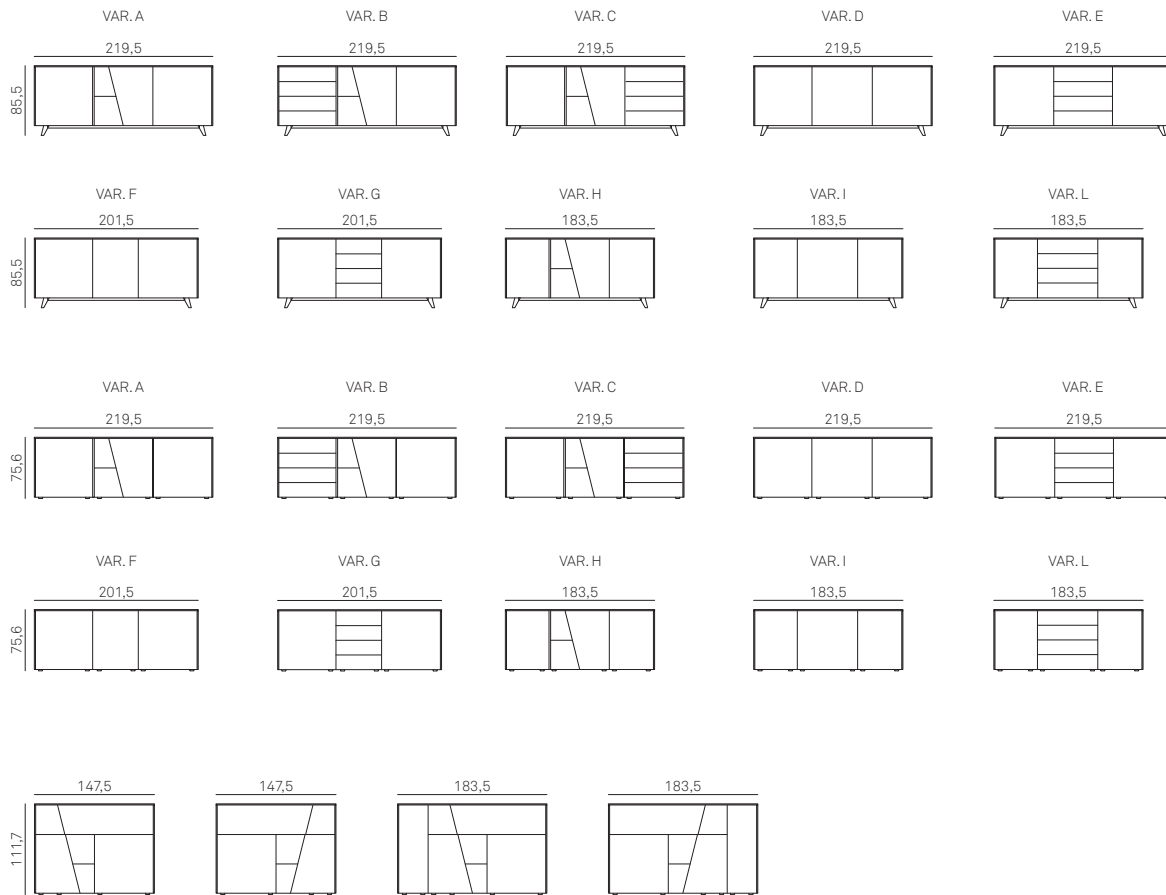

## FINITURE STRUTTURA / STRUCTURE FINISHES

ESSENZE / WOOD FINISHES



**LGN-FO**  
Frassino Oriente  
Eastern Ash



**LGN-RT**  
Rovere termocotto  
Heat-treated Oak

MATERICO ESSENZA /  
WOOD TEXTURE



**MT-FO**  
Frassino Oriente  
Eastern Ash



**MT-RT**  
Rovere termocotto  
Heat-treated Oak

MATERICO NODATO /  
KNOTTED TEXTURED



**MT-RNC**  
Nodato chiaro  
Light Knotted



**MT-RNS**  
Nodato scuro  
Dark knotted

MATERICO OPACO /  
MATT TEXTURED



**MT-OC BG**  
Bianco Gesso  
Chalk white



**MT-OC MP**  
Madreperla  
Mother of pearl



**MT-OC AN**  
Antracite  
Anthracite

MATERICO PORO APERTO /  
OPEN PORE MATERIC



**MT-PA BG**  
Bianco Gesso  
Chalk white

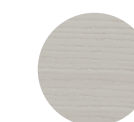

**MT-PA MP**  
Madreperla  
Mother of pearl

MATERICO /  
TEXTURED



**MT-CC**  
Cemento chiaro  
Light cement



**MT-CS**  
Cemento scuro  
Dark cement

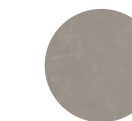

**MT-CV**  
Cemento cava  
Cava cement

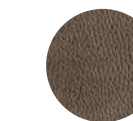

**MT-MB**  
Maya Bronze



**MT-INT C**  
Intreccio chiaro

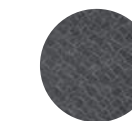

**MT-INT S**  
Intreccio scuro

LACCATI /  
LACQUERS

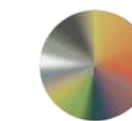

colori laccati opachi e lucidi  
a campionario (vedi pagina 333)  
choice of matt and gloss lacquer  
colours from our range (see page 333)

LEGNO LACCATO PORO APERTO /  
OPEN-PORE LACQUERED WOOD

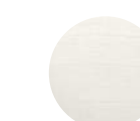

**221 PA**  
Bianco Gesso  
Chalk white

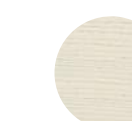

**222 PA**  
Panna  
Cream



**224 PA**  
Madreperla  
Mother of pearl



**227 PA**  
Hot  
Hot grey

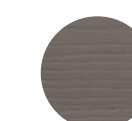

**230 PA**  
Grigio Piacenza  
Piacenza grey



**250 PA**  
Canapa  
Hemp



**252 PA**  
Pomice  
Pumice



**260 PA**  
Antracite  
Anthracite

## FINITURE BASAMENTO E VANI A GIORNO / BASE AND OPEN UNIT SFINISHES



**DI SERIE / STANDARD**  
Finitura Peltro  
Pewter finish



**DI SERIE / STANDARD**  
Finitura Antracite  
Anthracite finish

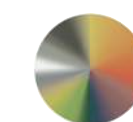

colori laccati opachi a campionario (vedi  
pagina 333)  
choice of matt lacquer colours  
from our range (see page 333)



# ATHENA



Madia Athena 3 ante struttura materico frassino oriente, inserti laccato opaco antracite 160 e basamento metallo antracite 160.  
L 181 P 51 H 85 cm

Pensile Ciko metallo antracite 160 e specchio argentato 381.  
L 36 P 24 H 36 cm

Wallpaper WPT 553.

3-door Athena sideboard with a textured eastern ash carcass, matt anthracite 160 lacquered inserts and anthracite 160 metal base.  
W 181 D 51 H 85 cm

Anthracite 160 metal ciko wall unit with silver 381 mirror.  
W 36 D 24 H 36 cm

WPT 553 wallpaper.





^  
**ATHENA**

Madia Athena particolare ante struttura materico rovere termocotto, inserti mosaico marrone.

Athena sideboard: detail of the doors, textured heat-treated oak carcass, brown mosaic inserts.

**ATHENA**

Madia Athena 3 ante struttura materico rovere termocotto, inserti materico opaco madreperla e basamento metallo madreperla 124.  
L 181 P 51 H 85 cm

Tappeto Frame.

3-door Athena sideboard with textured heat-treated oak carcass, textured matt mother or pearl inserts and mother of pearl 124 metal base.  
W 181 D 51 H 85 cm

Frame rug.







#### ATHENA

Madia Athena 3 ante struttura laccato opaco pomice 152, inserti vetro antracite 360, basamento metallo antracite 160.  
L 181 P 51 H 85 cm

3-door Athena sideboard with a matt pumice 152 lacquered carcass and anthracite 360 glass inserts. Anthracite 160 metal base.  
W 181 D 51 H 85 cm



## ATHENA



Struttura laccato opaco bianco gesso 121, inserti laccato opaco antracite 160, basamento metallo antracite 160.  
Matt chalk white 121 lacquered carcass with matt anthracite 160 lacquered inserts. Anthracite 160 metal base.



Struttura materico frassino oriente, inserti laccato opaco antracite 160 e basamento metallo antracite 160.  
Textured eastern ash carcass, matt anthracite 160 lacquered inserts and anthracite 160 metal base.



Struttura laccato opaco madreperla 124, inserti laccato opaco smoke 128, basamento metallo smoke 128.  
Matt 124 mother of pearl lacquered carcass, matt smoke 128 lacquered inserts, smoke 128 metal base.



Struttura laccato opaco smoke 128, inserti laccato opaco bordeaux 156, basamento metallo bordeaux 156.  
Matt 128 smoke lacquered carcass, matt burgundy 156 lacquered inserts, burgundy 156 metal base.



Struttura laccato opaco zafferano 158, inserti laccato opaco antracite 160, basamento metallo antracite 160.  
Matt saffron 158 lacquered carcass, matt anthracite 160 lacquered inserts, anthracite 160 metal base.



Struttura materico rovere termocotto, inserti laccato opaco madreperla 124, basamento metallo madreperla 124.  
Textured heat-treated oak carcass, matt mother of pearl 124 lacquered inserts and mother of pearl 124 metal base.



### ATHENA

Madia Athena 4 ante struttura laccato opaco carta da zucchero 155, inserti materico frassino oriente, basamento metallo carta da zucchero 155.  
L 121 P 51 H 141 cm

Lettering City metallo antracite 160.  
L 42 H 80 cm

Orologio 650.

4-door Athena sideboard with a matt blue grey 155 carcass, textured eastern ash inserts, blue grey 155 metal base.  
W 121 D 51 H 141 cm

Anthracite 160 metal City Lettering.  
W 42 H 80 cm

650 clock.



## ATHENA

misure / size L/W 181,2 P/D 51,5 H85,4 cm L/W 120,8 P/D 51,5 H 140,7 cm

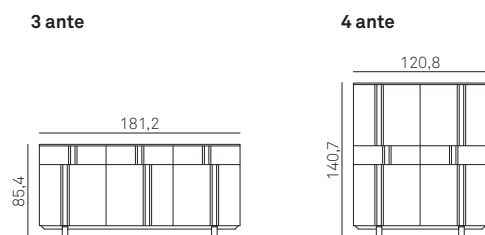

### FINITURE STRUTTURA / STRUCTURE FINISHES

#### MATERICO ESSENZA / TEXTURED MATERIC



**MT-FO**  
Frassino Oriente  
Eastern Ash

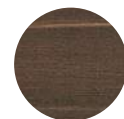

**MT-RT**  
Rovere termocotto  
Heat-treated Oak

#### MATERICO OPACO / MATT MATERIC

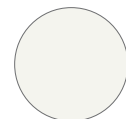

**MT-OC BG**  
Bianco Gesso  
Chalk white



**MT-OC MP**  
Madreperla  
Mother of pearl



**MT-OC AN**  
Antracite  
Anthracite

#### MATERICO PORO APERTO / OPEN PORE MATERIC



**MT-PA BG**  
Bianco Gesso  
Chalk white



**MT-PA MP**  
Madreperla  
Mother of pearl

### LEGNO LACCATO PORO APERTO / OPEN-PORE LACQUERED WOOD



**221 PA**  
Bianco Gesso  
Chalk white



**222 PA**  
Panna  
Cream



**224 PA**  
Madreperla  
Mother of pearl



**227 PA**  
Hot  
Hot grey



**230 PA**  
Grigio Piacenza  
Piacenza grey



**250 PA**  
Canapa  
Hemp



**252 PA**  
Pomice  
Pumice

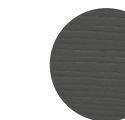

**260 PA**  
Antracite  
Anthracite

### LACCATI / LACQUERS

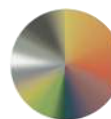

**colori laccati opachi a campionario**  
(vedi pagina 333)  
choice of matt lacquer colours from  
our range (see page 333)

### FINITURE BASAMENTO / BASE FINISHES



**DI SERIE / STANDARD**  
Finitura Peltro  
Pewter finish



**DI SERIE / STANDARD**  
Finitura Antracite  
Anthracite finish



**colori laccati opachi a campionario** (vedi  
pagina 333)  
choice of matt lacquer colours  
from our range (see page 333)

### FINITURE GOLA / GROOVE FINISHES

#### MATERICO ESSENZA / TEXTURED WOOD



**MT-FO**  
Frassino Oriente  
Eastern Ash



**MT-RT**  
Rovere termocotto  
Heat-treated Oak

#### MATERICO NODATO / KNOTTED TEXTURED



**MT-RNC**  
Nodato chiaro  
Light Knotted

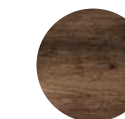

**MT-RNS**  
Nodato scuro  
Dark knotted

#### MATERICO / TEXTURED



**MT-CC**  
Cemento chiaro  
Light cement



**MT-CS**  
Cemento scuro  
Dark cement

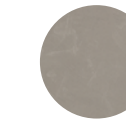

**MT-CV**  
Cemento cava  
Cava cement

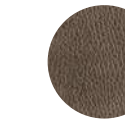

**MT-MB**  
Maya Bronze

#### MATERICO OPACO / MATT TEXTURED



**MT-OC BG**  
Bianco Gesso  
Chalk white



**MT-OC MP**  
Madreperla  
Mother of pearl



**MT-OC AN**  
Antracite  
Anthracite

#### MATERICO PORO APERTO / OPEN PORE TEXTURED

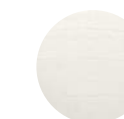

**MT-PA BG**  
Bianco Gesso  
Chalk white



**MT-PA MP**  
Madreperla  
Mother of pearl

#### MOSAICO / MOSAIC

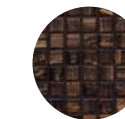

Marrone  
Brown

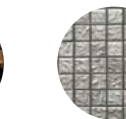

Argento  
Silver



Grigio  
Grey

### LEGNO LACCATO PORO APERTO / OPEN-PORE LACQUERED WOOD



**221 PA**  
Bianco Gesso  
Chalk white



**222 PA**  
Panna  
Cream

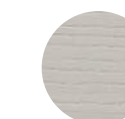

**224 PA**  
Madreperla  
Mother of pearl



**227 PA**  
Hot  
Hot grey



**230 PA**  
Grigio Piacenza  
Piacenza grey



**250 PA**  
Canapa  
Hemp



**252 PA**  
Pomice  
Pumice



**260 PA**  
Antracite  
Anthracite

### LACCATI / LACQUERS

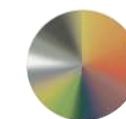

**colori laccati opachi a campionario**  
(vedi pagina 333)  
choice of matt lacquer colours  
from our range (see page 333)

### VETRO / GLASS



**vetro lucido colorato a campionario**  
(vedi pagina 334)  
choice of gloss coloured glass from our  
range (see page 334)

Athena con gola laccata o in vetro colorato ha il  
basamento in tinta laccata colore.  
Athena with coloured glass or lacquered grooves has a  
lacquered base in a matching colour.





Madia Madison struttura laccato opaco  
antracite 160.  
L 207 P 49 H 76 cm

Tavolino 33 versione 13.  
Ø 40 H 38 cm

Madison sideboard with a matt  
anthracite 160 lacquered carcass.  
W 207 D 49 H 76 cm

33 coffee table, version 13.  
Ø 40 H 38 cm





Madison con lama luminosa RGB spessore 20 mm.  
Madison with 20mm-thick illuminated RGB blade.

## MADISON

Madia Madison struttura laccato opaco bianco gesso 121.  
L 207 P 49 H 76 cm

Pensile Ciko metallo antracite 160, grafica 260, 235, e laccato opaco salvia 159.  
L 36 P 24 H 36 cm

Orologio 630.

Madison sideboard with a matt anthracite chalk white 121 lacquered carcass.  
W 207 D 49 H 76 cm

Anthracite 160 and graphic 260, 235 metal and matt sage 159 lacquered Ciko wall unit.  
W 36 D 24 H 36 cm

630 clock.

## MADISON

misure / size L/W 206,8 P/D 48,5 H 75,9 cm

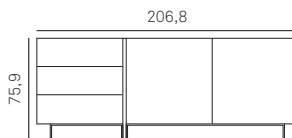

## FINITURE STRUTTURA / STRUCTURE FINISHES

LACCATI / LACQUERS

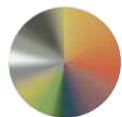

colori laccati opachi a campionario  
(vedi pagina 333)  
choice of matt lacquer colours from  
our range (see page 333)





Madia Atlante laccato opaco smoke 128 e specchio grigio satinato 383.  
L 240 P 54 H 76 cm

Sedia Lolita struttura rovere termocotto,  
rivestimento cat. b hugo 04.  
L 51 P 56 H 79/47 cm

Matt smoke 128 lacquered Atlante sideboard with a satin grey 383 mirror.  
W 240 D 54 H 74 cm

Lolita chair with a heat-treated oak frame upholstered with cat. b hugo 04.  
W 51 D 56 H 79/47 cm



## ATLANTE

misure / size L/W 192 P/D 54 H 76 cm L/W 192 P/D 54 H 96 cm  
L/W 240 P/D 54 H 76 cm L/W 240 P/D 54 H 96 cm

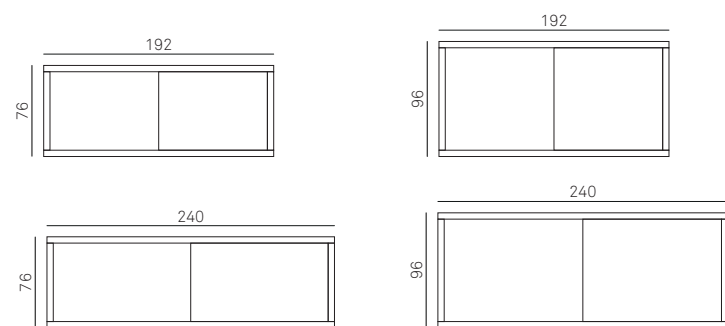

### FINITURE STRUTTURA / CARCASS FINISHES

LEGNO LACCATO PORO APERTO / OPEN-PORE LACQUERED WOOD



**221 PA**  
Bianco Gesso  
Chalk white

**222 PA**  
Panna  
Cream

**224 PA**  
Madreperla  
Mother of pearl

**227 PA**  
Hot  
Hot grey

**230 PA**  
Grigio Piacenza  
Piacenza grey

**250 PA**  
Canapa  
Hemp

**252 PA**  
Pomice  
Pumice

**260 PA**  
Antracite  
Anthracite

colori laccati lucidi e opachi a campionario (vedi pagina 333)  
choice of gloss and matt lacquer colours from our range (see page 333)

### FINITURE ANTA / DOOR FINISHES

LEGNO LACCATO PORO APERTO / OPEN-PORE LACQUERED WOOD

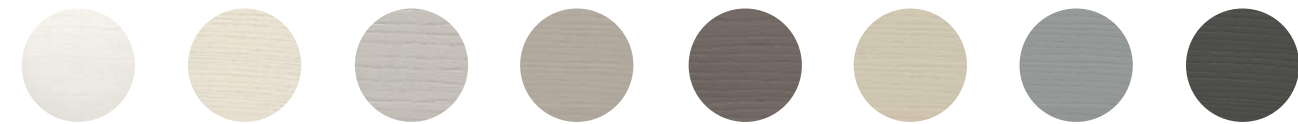

**221 PA**  
Bianco Gesso  
Chalk white

**222 PA**  
Panna  
Cream

**224 PA**  
Madreperla  
Mother of pearl

**227 PA**  
Hot  
Hot grey

**230 PA**  
Grigio Piacenza  
Piacenza grey

**250 PA**  
Canapa  
Hemp

**252 PA**  
Pomice  
Pumice

**260 PA**  
Antracite  
Anthracite



vetro lucido colorato a campionario (vedi pagina 334)  
choice of gloss coloured glass from our range (see page 334)



Specchio grigio satinato 393  
Satin grey mirror 393



Specchio grigio 383  
Grey mirror 383

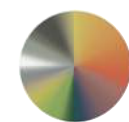

colori laccati lucidi e opachi a campionario (vedi pagina 333)  
choice of gloss and matt lacquer colours from our range (see page 333)

## ATLANTE

Madia Atlante legno laccato poro aperto hot 127 e specchio grigio satinato 393.  
L 192 P 54 H 76 cm

Tappeto Frame.

Atlante sideboard in open-pore hot grey 127 lacquered wood with a satin grey 393 mirror.  
W 192 D 54 H 76 cm

Frame rug.





# poltrone e pouf

armchairs and poufs

Lasciarsi avvolgere dal design per sprofondare nella comodità: poltrone e pouf creano piccole oasi di benessere e angoli di assoluto relax all'interno di ogni stanza.

Sink into the embrace of design at its comfortable best: armchairs, ottomans and floor cushions create little havens of wellbeing and chill-out corners in each room for switching off and unwinding.





Poltroncina Loft struttura legno rovere termocotto,  
rivestimento cat. b joy.  
L 59 P 70 H 64 cm

Divanetto Loft struttura legno rovere termocotto,  
rivestimento cat. b econabuk 5.  
L 124 P 75 H 70 cm

Tavolino Caruso piano laccato opaco bianco gesso  
121, basamento metallo antracite 160.  
L 44 P 44 H 43 cm

Loft armchair with a heat-treated oak wood frame  
upholstered with cat. b joy fabric.  
W 59 D 70 H 64 cm

Loft 2-seater sofa with a heat-treated oak wood  
frame upholstered with cat. b eco-nubuck 5.  
W 124 D 75 H 70 cm

Caruso coffee table with matt chalk white 121  
lacquered top and anthracite 160 metal base.  
W 44 D 44 H 43 cm

LOFT





#### LOFT

Poltroncina Loft struttura legno rovere termocotto, rivestimento cat. b econabuk 5. L 59 P 70 H 64 cm

Tavolino Brigitte laccato opaco antracite 160 e metallo antracite 160. Ø 45 H 52 cm

Loft armchair with a heat-treated oak wood frame upholstered with cat. b eco-nubuck 5. W 59 D 70 H 64 cm

Brigitte coffee table in matt anthracite 160 lacquer and anthracite 160 metal. Ø 45 H 52 cm



Loft poltroncina o divanetto:  
per interni cosmopoliti.

Loft armchair or 2-seater sofa:  
designed for cosmopolitan interiors.

## LOFT

misure / size **poltrona / occasional chair:** L/W 65 P/D 75 H 70 cm  
**divanetto / sofa:** L/W 124 P/D 75 H 70 cm  
**mignon:** L/W 59 P/D 70 H 64 cm

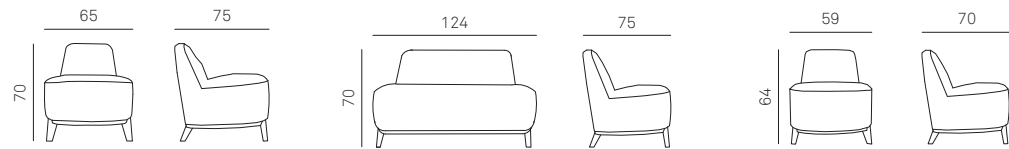

## FINITURE STRUTTURA / FRAME FINISHES

### ESSENZE / WOOD FINISHES



**LGN-FO**  
Frassino Oriente  
Eastern Ash



**LGN-RT**  
Rovere Termocotto  
Heat-treated Oak

## RIVESTIMENTO / COVERING

**Econabuk, ecopelle e pelle**  
Eco-nubuck, eco-leather and leather upholstery



**Tessuti del campionario**  
Our range of fabrics



## LOFT

Divanetto Loft struttura legno  
frassino oriente, rivestimento  
cat. b econabuk 5.  
L 124 P 75 H 70 cm  
Wallpaper WPT 535.

Loft 2-seater sofa with an  
eastern ash wood frame  
upholstered with cat. b  
eco-nubuck 5.  
W 124 D 75 H 70 cm  
WPT 535 wallpaper.





## FLOWER

Poltrona Flower  
01. cat. 1/one easy 20, filo 3426.  
02. cat. 1/one easy 18, filo 877.  
03. cat. 1/one point 16, filo 0856.  
L 85 P 75 H 75/40 cm

Flower armchair  
01. cat. 1/one easy 20, yarn 3426.  
02. cat. 1/one easy 20, yarn 877.  
03. cat. 1/one point 16, yarn 0856.  
W 85 D 75 H 75/40 cm

NEW  
YORK  
ROME  
LONDON  
PARIS  
PICCOLI  
LIVELLI  
NEW



01.

02.

03.



## FLOWER



cat. b ecopelle vintage 106.  
cat. b vintage 106 eco-leather.



cat. b ecopelle vintage 106.  
cat. b vintage 106 eco-leather.



cat. b ecopelle vintage 106, cat. c lino froissé 022.  
cat. b vintage 106 eco-leather, cat. c froissé linen 022.



cat. b ecopelle vintage 106, cat. c lino froissé 022.  
cat. b vintage 106 eco-leather, cat. c froissé linen 022.



cat. b ecopelle vintage 106, cat. c lino froissé 022.  
cat. b vintage 106 eco-leather, cat. c froissé linen 022.

misure / size

**poltrona / occasional chair:** L/W 85 P/D 75 H 75 cm  
**pouff / ottoman:** L/W 65 P/D 65 H 40 cm

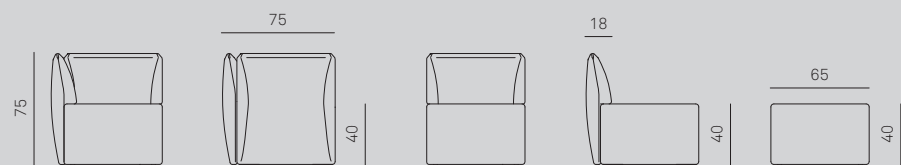

RIVESTIMENTO / COVERING

Econabuk, ecopelle e pelle  
Eco-nubuck, eco-leather and leather upholstery



Tessuti del campionario  
Our range of fabrics



tagliacuci (escluso per rivestimento in pelle)  
piping (except for leather upholstery)

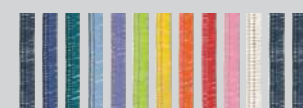

## FLOWER

Poltrona Flower cat. f pelle vintage 102.  
L 85 P 75 H 75/40 cm

Tavolino Joy Decor piano grafica 150, basamento metallo antracite 160.  
Ø 45 H 46 cm

Wallpaper WPT550.

Flower armchair upholstered with cat. f vintage 102 leather.  
W 85 D 75 H 75/40 cm

Joy Decor coffee table with graphic 150 top, anthracite 160 metal base.  
Ø 45 H 46 cm

WPT550 wallpaper.



# SOFT

Poltroncina Soft  
01. cat. d lino froissè 123.  
02. cat. d lino froissè 05.  
03. cat. d lino froissè 100.  
04. cat. d lino froissè 116.  
L 66 P 95 H 72/41 cm

Tavolino Joy piano  
materico nodato chiaro,  
basamento metallo antracite 160.  
Ø 60 H 38 cm

Tappeto Frame.

Soft armchair  
01. cat. d froissè linen 123.  
02. cat. d froissè linen 05.  
03. cat. d froissè linen 100.  
04. cat. d froissè linen 116.  
W 66 D 95 H 72/41 cm

Joy coffee table with textured light knotted  
top, anthracite 160 metal base.  
Ø 60 H 38 cm

Frame rug.



01.

02.

03.

04.



Un mondo di quiete.  
Una poltrona comoda e accomodante, per interiors e spazi dove liberare la mente e rilassarsi in tutta tranquillità.

A world of peaceful calm.  
A comfortable and casually relaxed chair for interiors and spaces where you can tune out the world and unwind in peace.

## SOFT

misure / size **poltrona / occasional chair:** L/W 66 P/W 95 H 72/41 **pouff / ottoman:** L/W 66 P/D 66 H 41 cm

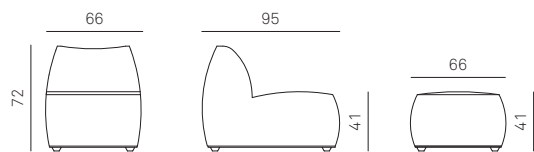

### RIVESTIMENTO / COVERING

**Econabuk, ecopelle e pelle**  
Eco-nubuck, eco-leather and leather upholstery



**Tessuti del campionario**  
Our range of fabrics



Poltroncina Soft cat. d lino froissé 011.  
L 66 P 95 H 72/41 cm

Tavolino Joy Decor piano grafica 111,  
basamento metallo zafferano 158.  
Ø 45 H 46 cm

Soft armchair upholstered with cat. d  
froissé linen 011.  
W 66 D 95 H 72/41 cm

Joy Decor coffee table with graphic 111  
top, saffron 158 metal base.  
Ø 45 H 46 cm



Poltrona Maya cat. b ecopelle vintage 101 e cat. d linara 13. L 72 P 84 H 79/43 cm

Tavolino Caruso metallo bianco gesso 121. L 44 P 44 H 43 cm

Panketta materico nodato chiaro, struttura metallo antracite 160. L 216 P 38 H 45 cm

Raster metallo bianco gesso 121 e materico nodato chiaro. L 144 P 30 H 18 cm

Plaid Cuzco.

Wallpaper WPT527.

Maya chair upholstered with cat. b vintage 101 eco-leather and cat. d linara 13 fabric. W 72 D 84 H 79/43 cm

Caruso coffee table in matt chalk white 121 metal. L 44 W 44 H 43 cm

Textured light knotted Panketta bench with anthracite 160 metal frame. L 216 W 38 H 45 cm

Chalk white 121 metal and textured light knotted Raster unit. W 144 D 30 H 18 cm

Cuzco throw.

WPT527 wallpaper.

## MAYA



Poltroncina Maya,  
doppia imbottitura con cuscino.

—

Maya armchair:  
double upholstery with cushion.

## MAYA

misure / size L/W 72 P/D 84 H 79/43 cm

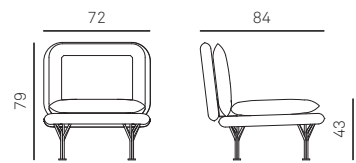

### FINITURA PIEDI / FEET FINISHES

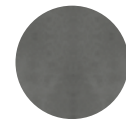

Finitura Peltro  
Pewter finish

### RIVESTIMENTO STRUTTURA IMBOTTITA / PADDED UPHOLSTERY ON FRAME

Econabuk, ecopelle e pelle  
Eco-nubuck, eco-leather  
and leather upholstery



Tessuti del campionario  
Our range of fabrics



### RIVESTIMENTO SEDUTA E SCHIENALE / SEAT AND BACKREST FINISHES

Econabuk, ecopelle e pelle  
Eco-nubuck, eco-leather  
and leather upholstery



Tessuti del campionario  
Our range of fabrics



Poltrona Maya cat. b ecopelle  
vintage 107, cat.1/one easy 21.  
L 72 P 84 H 79/43

Tavolino Brigitte laccato opaco  
antracite 160.  
Ø 45 H 52 cm

Maya chair upholstered with cat. b  
vintage 107 eco-leather and cat. 1/  
one easy 21 fabric.  
W 72 D 84 H 79/43

Brigitte coffee table in matt  
anthracite 160 lacquer.  
Ø 45 H 52 cm





Un senso di protezione.

A dettare lo stile della poltrona è soprattutto il design dello schienale alto che, in pelle, ecopelle, econabuk o tessuto, è avvolgente come un abbraccio.

A sense of protection.

The armchair's style is dictated, above all, by the design of its high back, which is upholstered in leather, eco-leather, eco-nubuck or fabric and wraps round the occupant in a hug.

## VANESSA

misure / size L/W 64 P/D 64 H 90/50 cm

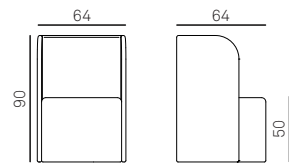

### RIVESTIMENTO / COVERING

**Econabuk, ecopelle e pelle**  
Eco-nubuck, eco-leather and leather upholstery



**Tessuti del campionario**  
Our range of fabrics



VANESSA

Poltroncina Vanessa  
cat. c lino froissé 011.  
L 64 P 64 H 90/50 cm

Tavolino Caruso laccato  
opaco bianco gesso 121.  
L 44 P 44 H 43 cm

Plaid Lino sacco.  
L 150 P 195 cm

Vanessa armchair  
upholstered with opt. c  
froissé linen 011 fabric.  
W 64 D 64 H 90/50 cm

Caruso coffee table in matt  
chalk white 121 lacquer.  
L 44 W 44 H 43 cm

Lino Sacco throw.  
L 150 W 195 cm



Comodità al femminile.  
Le cuciture attraversano lo schienale imbottito e lo valorizzano.  
L'amore per il dettaglio e la cura sartoriale si siedono qui.

Comfort shows its feminine side.  
Stitching runs across the padded back for added luxury.  
A love of detail and skilful tailoring sit happily side by side.

## LINDA

misure / size L/W 67 P/D 67 H 75 cm

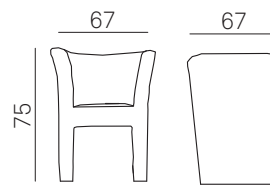

### RIVESTIMENTO / COVERING

Econabuk, ecopelle e pelle  
Eco-nubuck, eco-leather and leather upholstery



## LINDA

Poltroncina Linda  
cat. 1/one atom 34.  
L 67 P 67 H 75 cm

Tavolino Brigitte piano  
materico cemento chiaro,  
struttura metallo hot 127.  
ø 45 H 52 cm

Linda armchair upholstered  
with cat. 1/one atom 34.  
W 67 D 67 H 75 cm

Brigitte coffee table with  
textured light cement top and  
hot grey 127 metal frame.  
ø 45 H 52 cm





Informali, originali, morbidi e scanzonati, i pouf danno nuove forme alla convivialità. Quasi mai da soli, in compagnia danno il meglio di sé.

Casual, original, soft and easygoing, ottomans add a new twist to any hang-out zone. Rarely solitary, they really come into their own when they're in company.





Cookie pouf con rivestimento in vari tessuti.

Cookie ottomans covered in various fabrics.



**COOKIE**

misure / size L/W 47 P/D 47 H 46 cm

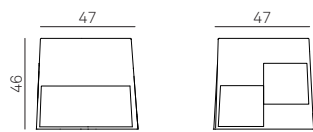

**RIVESTIMENTO / COVERING**

**Econabuk, ecopelle e pelle**  
Eco-nubuck, eco-leather and leather upholstery



**Tessuti del campionario**  
Our range of fabrics



**tagliacuci (escluso per rivestimento in pelle)**  
piping (except for leather upholstery)

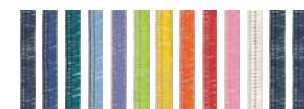



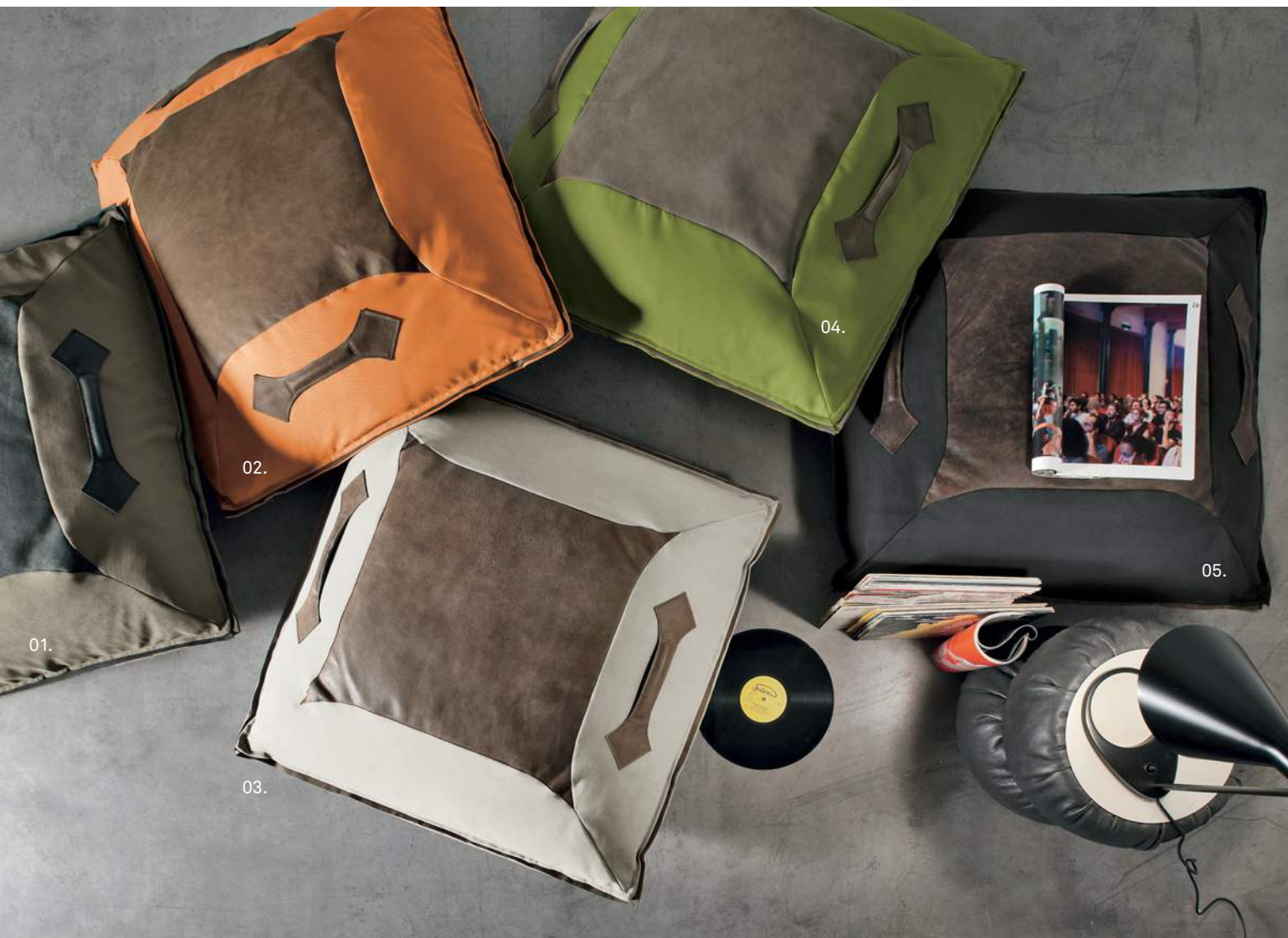

Giglio 01.  
cat. 1/one point 28, cat. b ecopelle vintage 107.  
cat. 1/one point 28, cat. b vintage 107 eco-leather.

Giglio 02.  
cat. c lino froissè 006, cat. b ecopelle vintage 103.  
cat. c froissè linen 006, cat. b vintage 103 eco-leather.

Giglio 03.  
cat. 1/one point 01, cat. b ecopelle vintage 103.  
cat. 1/one point 01, cat. b vintage 103 eco-leather.

Giglio 04.  
cat. c lino froissè 015, cat. b ecopelle vintage 102.  
cat. c froissè linen 015, cat. b vintage 102 eco-leather.

Giglio 05.  
cat. 1/one point 16, cat. b ecopelle vintage 106.  
cat. 1/one point 16, cat. b vintage 106 eco-leather.

## GIGLIO

misure / size L/W 85 P/D 85 H 30 cm

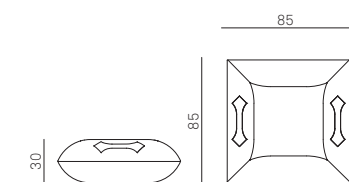

### RIVESTIMENTO / COVERING

Tessuti del campionario  
Our range of fabrics



### INSERTO E MANIGLIE / INSERT AND HANDLES

Ecopelle Vintage  
Vintage eco-leather



Giglio 06.  
cat. 1/one point 01, cat. b ecopelle vintage 102.  
cat. 1/one point 01, cat. b vintage 102 eco-leather.

Giglio 07.  
cat. 1/one point 28, cat. b ecopelle vintage 107.  
cat. 1/one point 28, cat. b vintage 107 eco-leather.

Giglio 08.  
cat. 1/one point 11, cat. b ecopelle vintage 103.  
cat. 1/one point 11, cat. b vintage 103 eco-leather.

Giglio 09.  
cat. 1/one point 06, cat. b ecopelle vintage 103.  
cat. 1/one point 06, cat. b vintage 103 eco-leather.





Pouf Guccino  
laccato opaco madreperla  
124, cat. c linara 16.  
laccato opaco madreperla  
124, cat. c linara 03.  
Ø 40 H 53 cm

Guccino pouf  
matt mother of pearl 124  
lacquered, cat. c linara 16.  
matt mother of pearl 124  
lacquered, cat. c linara 03.  
Ø 40 H 53 cm



## GUCCINO

misure / size Ø 40 H 53 cm

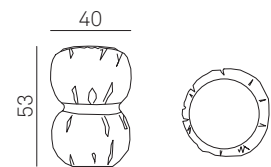

### FINITURA TOP / TOP FINISHES

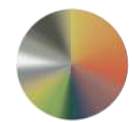

colori laccati opachi a campionario  
(vedi pagina 333)  
choice of matt lacquer colours  
from our range (see page 333)

### RIVESTIMENTO / COVERING

Econabuk, ecopelle e pelle  
Eco-nubuck, eco-leather and  
leather upholstery



Tessuti del campionario  
Our range of fabrics





## COMODO

misure / size L 85 P 85 H 85 cm

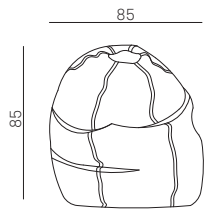

Comodo 01.  
cat. 1/one easy 18, filo 877.  
cat. 1/one easy 18, yarn 877.

Comodo 02.  
cat. c lino froissè 100 e 033, filo 877.  
cat. c froissè linen 100 and 033 fabric,  
yarn 877.

Comodo 03.  
cat. b ecopelle vintage 107, filo 877.  
cat. b vintage 107 eco-leather, yarn  
877.

Comodo 04.  
cat. b texas 28, filo 877.  
cat. b texas 28, yarn 877.

Comodo 05.  
cat. b texas 31 e 12, filo 877.  
cat. b texas 31 and 12, yarn 877.

Comodo 06.  
cat. 1/one easy 20, filo 3426.  
cat. 1/one easy 20, yarn 3426.  
L 85 P 85 H 85 cm

Libreria Movida struttura metallo  
bianco gesso 121, ripiani materico  
nodato chiaro.  
L 74 P 38 H 190 cm

Movida bookcase with chalk white 121  
metal frame and textured light knotted  
shelves.  
W 74 D 38 H 190 cm

Tappeto Gradient.  
Gradient rug.





# tavolini

coffee tables

Utili in ogni situazione, perfetti in tutte le stanze, piccoli luoghi di incontro o pratici piani di appoggio, i tavolini sono molto funzionali e affiancano divani, sedute o letti con la varietà delle loro forme.

Handy whatever the situation, perfect in any room, providing a focal point for little get-togethers or practical set-down space, coffee and side tables are highly functional and their myriad shapes make them a perfect companion for sofas, seating or beds.





Tavolino Joy

- 01. piano materico cemento chiaro, struttura metallo peltro. Ø 100 H 26 cm
- 02. piano materico nodato scuro, struttura metallo peltro. Ø 60 H 39 cm
- 03. piano laccato opaco bianco gesso 121, struttura metallo peltro. Ø 100 H 26 cm
- 04. piano materico cemento scuro, struttura metallo peltro. Ø 60 H 39 cm
- 05. piano materico nodato chiaro, struttura metallo bianco gesso 121. Ø 100 H 26 cm
- 06. piano laccato opaco bianco gesso 121, struttura metallo bianco gesso 121. Ø 100 H 26 cm

Joy coffee table.

- 01. textured light cement top, pewter metal frame. Ø 100 H 26 cm
- 02. textured dark knotted top, pewter metal frame. Ø 60 H 39 cm
- 03. chalk white 121 lacquered top, pewter metal frame. Ø 100 H 26 cm
- 04. textured dark cement top, pewter metal frame. Ø 60 H 39 cm
- 05. textured light knotted top, chalk white 121 metal frame. Ø 100 H 26 cm
- 06. chalk white 121 lacquered top, chalk white 121 metal frame. Ø 100 H 26 cm

JOY





## JOY

misure / size    Ø 45 H 47cm    Ø 60 H 39 cm    Ø 100 H 26 cm



### FINITURE BASAMENTO / BASE FINISHES

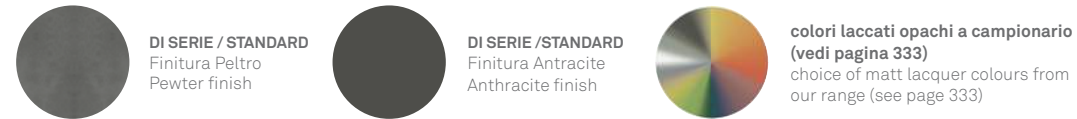

### FINITURE PIANO / TOP FINISHES

#### MATERICO ESSENZA / TEXTURED WOOD



#### MATERICO NODATO / KNOTTED TEXTURED

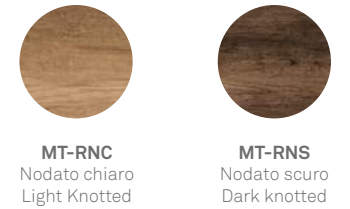

#### MATERICO OPACO / MATT MATERIC

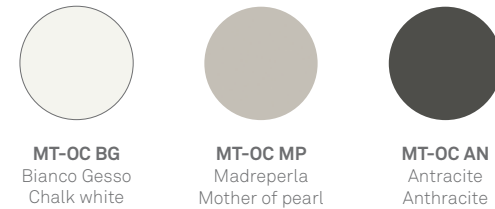

#### MATERICO / TEXTURED



#### MATERICO PORO APERTO / OPEN PORE MATERIC



#### LEGNO LACCATO PORO APERTO / OPEN-PORE LACQUERED WOOD



#### HPL

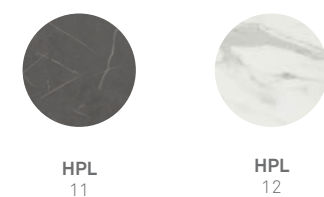

#### LACCATI / LACQUERS

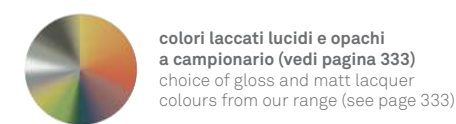

Tavolino Joy  
01. piano materico cemento chiaro,  
struttura metallo antracite 160.  
Ø 100 H 26 cm

02. piano materico nodato chiaro,  
struttura metallo antracite 160.  
Ø 60 H 39 cm

03. piano materico cemento scuro,  
struttura metallo antracite 160.  
Ø 45 H 47 cm

Tappeto Gradient.

Joy coffee table  
01. textured light cement top,  
anthracite 160 metal frame.  
Ø 100 H 26 cm

02. textured light knotted top,  
anthracite 160 metal frame.  
Ø 60 H 39 cm

03. textured dark cement top,  
anthracite 160 metal frame.  
Ø 45 H 47 cm

Gradient rug.

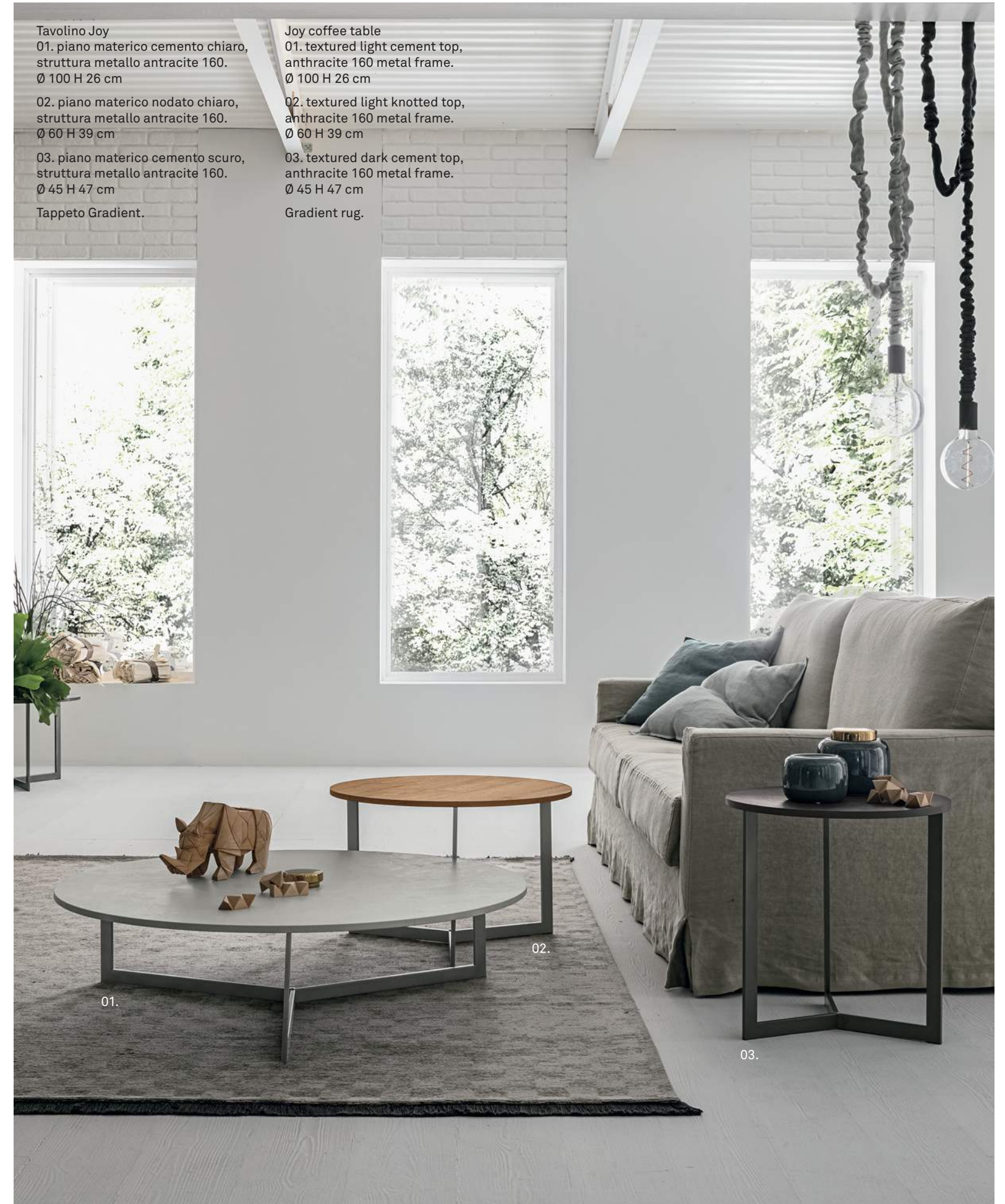



## JOY DECOR

misure / size    Ø 45 H 46 cm    Ø 60 H 38 cm    Ø 100 H 25 cm (no grafica)



### FINITURE BASAMENTO / BASE FINISHES

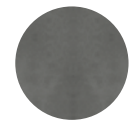

**DI SERIE / STANDARD**  
Finitura Peltro  
Pewter finish



**DI SERIE / STANDARD**  
Finitura Antracite  
Anthracite finish

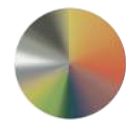

**colori laccati opachi a campionario**  
(vedi pagina 333)  
choice of matt lacquer colours from  
our range (see page 333)

### GRAFICHE TOP / TOP GRAPHIC

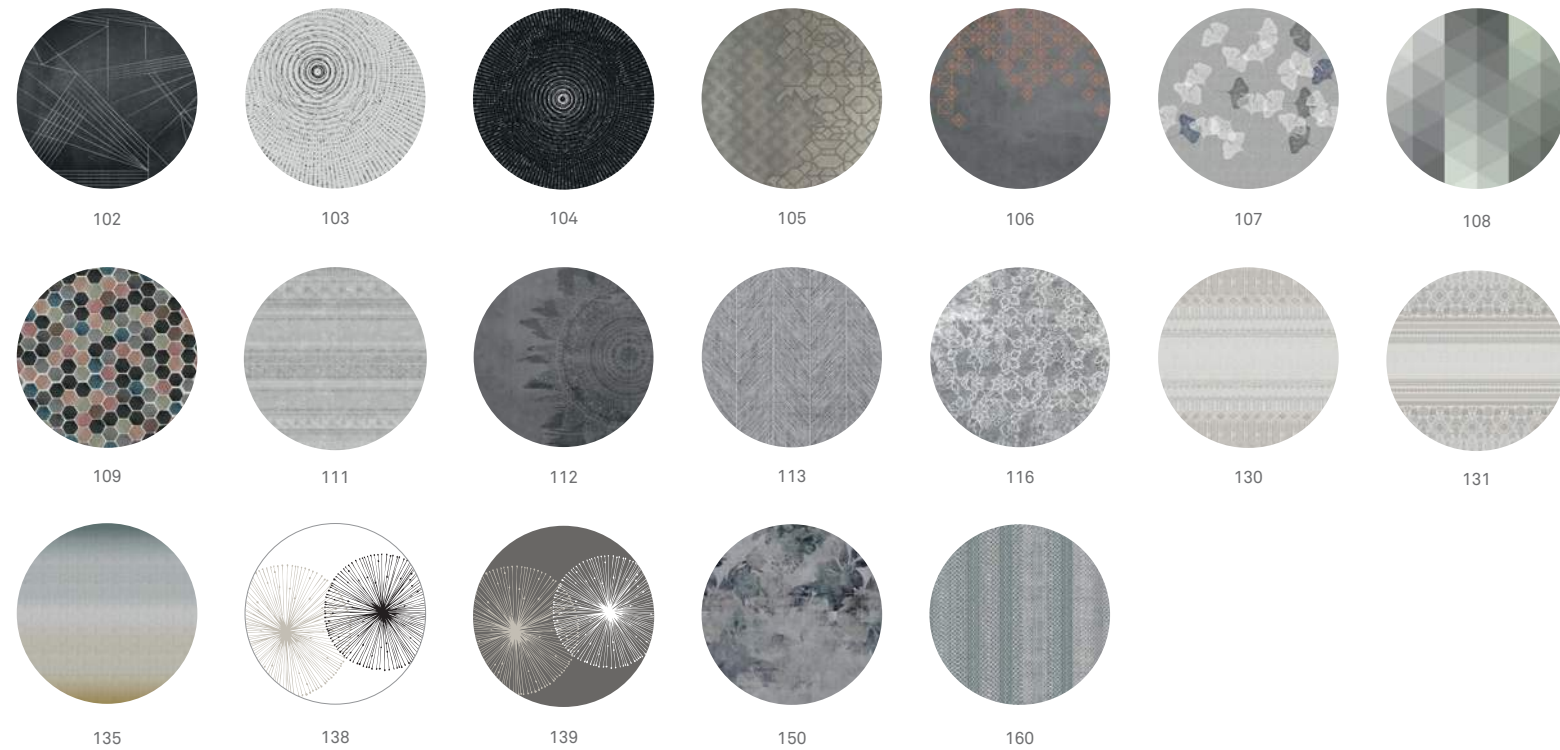

Tavolino Joy decor vari colori di struttura e 19 diverse grafiche creative per il top.

Joy decor coffee table in various frame colours and 19 different creative graphic designs for the top.



Tavolino Wood:  
la natura nel tuo salotto.

Wood coffee table:  
nature in your living room.

## JOY WOOD

misure / size    Ø 45 H 46 cm    Ø 60 H 38 cm

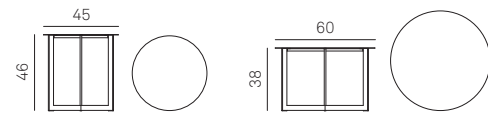

### FINITURE TOP / TOP FINISHES



**Noce Canaletto**  
Black walnut  
Ø 45



**Rovere**  
Oak  
Ø 60

### FINITURE BASAMENTO / BASE FINISHES

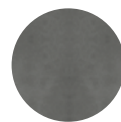

**DI SERIE / STANDARD**  
Finitura Peltro  
Pewter finish



**DI SERIE / STANDARD**  
Finitura Antracite  
Anthracite finish

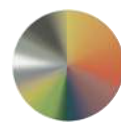

**colori laccati opachi a campionario**  
(vedi pagina 333)  
choice of matt lacquer colours from  
our range (see page 333)



01.

Tavolino Joy Wood

01. piano legno rovere, struttura metallo  
bianco gesso 121.  
Ø 60 H 38 cm

02. piano legno noce canaletto, struttura  
metallo antracite 160.  
Ø 45 H 46 cm

02.

Joy Wood coffee table  
01. oak wood top, chalk white 121 metal  
frame.  
Ø 60 H 38 cm

02. black walnut wood top, anthracite 160  
metal frame.  
Ø 45 H 46 cm



La forma è tutto.  
Una sagoma irregolare per un tavolino dallo spirito moderno.  
Leggero nelle linee ma allo stesso tempo forte nel design.

Form is everything.  
An irregular shape for a modern-minded side table.  
Light in its lines yet strong in design.

## CARUSO

misure / size L/W 44,5 cm P/D 44 cm H 43,1 cm

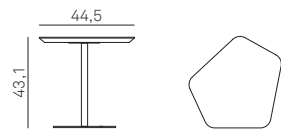

### FINITURA PIANO / TOP FINISHES

LACCATI / LACQUERS

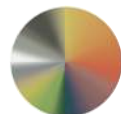

colori laccati opachi a campionario  
(vedi pagina 333)  
choice of matt lacquer colours from  
our range (see page 333)

### FINITURA BASAMENTO / BASE FINISHES



DI SERIE / STANDARD  
Laccato bianco gesso  
Chalk white lacquered



colori laccati opachi a campionario  
(vedi pagina 333)  
choice of matt lacquer colours  
from our range (see page 333)



CARUSO

Tavolino Caruso  
01. laccato opaco pomice 152.  
02. laccato opaco bianco gesso 121.  
L 44,5 P 44 H 43,1 cm

Caruso coffee table  
01. matt pumice 152 lacquer.  
02. matt chalk white 121 lacquer.  
L 44,5 W 44 H 43,1 cm

01.

02.



## ECLISSE

misure / size L/W 55 P/D 44 H 45 cm

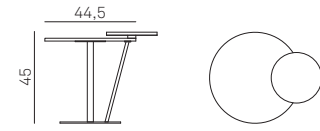

### FINITURE BASAMENTO E VASSOIO / BASE AND TRAY FINISHES



**DI SERIE / STANDARD**  
Laccato bianco gesso  
Chalk white lacquered

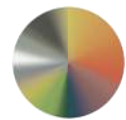

**colori laccati opachi a campionario**  
(vedi pagina 333)  
choice of matt lacquer colours from  
our range (see page 333)

### FINITURE PIANO / TOP FINISHES

#### MATERICO ESSENZA / TEXTURED WOOD



**MT-FO**  
Frassino Oriente  
Eastern Ash



**MT-RT**  
Rovere termocotto  
Heat-treated Oak

#### MATERICO NODATO / KNOTTED TEXTURED



**MT-RNC**  
Nodato chiaro  
Light Knotted



**MT-RNS**  
Nodato scuro  
Dark knotted

#### MATERICO OPACO / MATT MATERIC



**MT-OC BG**  
Bianco Gesso  
Chalk white



**MT-OC MP**  
Madreperla  
Mother of pearl



**MT-OC AN**  
Antracite  
Anthracite

#### MATERICO / TEXTURED



**MT-CC**  
Cemento chiaro  
Light cement



**MT-CS**  
Cemento scuro  
Dark cement

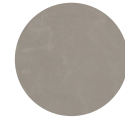

**MT-CV**  
Cemento cava  
Cava cement

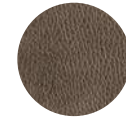

**MT-MB**  
Maya Bronze



**MT-INT C**  
Intreccio chiaro



**MT-INT S**  
Intreccio scuro

#### MATERICO PORO APERTO / OPEN PORE MATERIC



**MT-PA BG**  
Bianco Gesso  
Chalk white



**MT-PA MP**  
Madreperla  
Mother of pearl

#### LEGNO LACCATO PORO APERTO / OPEN-PORE LACQUERED WOOD



**221 PA**  
Bianco Gesso  
Chalk white



**222 PA**  
Panna  
Cream



**224 PA**  
Madreperla  
Mother of pearl



**227 PA**  
Hot  
Hot grey



**230 PA**  
Grigio Piacenza  
Piacenza grey



**250 PA**  
Canapa  
Hemp



**252 PA**  
Pomice  
Pumice



**260 PA**  
Antracite  
Anthracite

#### LACCATI / LACQUERS

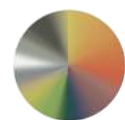

**colori laccati opachi e lucidi a campionario**  
(vedi pagina 333)  
choice of matt and gloss lacquer  
colours from our range (see page 333)



## ECLISSE

Tavolino Eclisse laccato opaco bianco gesso 121, materico nodato scuro. L 55 P 45 H 45 cm

Eclisse coffee table in matt chalk white 121 lacquer and textured dark knotted finish. L 55 W 45 H 45 cm



# BRIGITTE

Tavolini Brigitte  
01. Piano Hpl 11, struttura metallo hot 127.  
Ø 45 H 52 cm  
02. Piano Hpl 11, struttura salvia 159.  
Ø 45 H 52 cm  
03. Piano Hpl 11, struttura hot 127.  
Ø 100 H 30 cm

Tappeto Gradient.

Brigitte coffee tables  
01. HPL 11 top, hot grey 127 metal frame.  
Ø 45 H 52 cm  
02. HPL 11 top, sage 159 frame.  
Ø 45 H 52 cm  
03. HPL 11 top, hot grey 127 frame.  
Ø 100 H 30 cm

Gradient rug.



01.

02.

03.



BRIGITTE



Piano materico cemento chiaro, struttura metallo bianco gesso 121. Textured light knotted top, chalk white 121 metal frame.



Piano laccato opaco antracite 160, struttura metallo bordeaux 156. Matt anthracite 160 lacquered top, burgundy 156 metal frame.

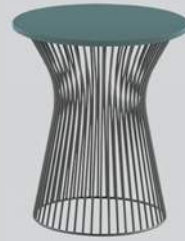

Piano laccato opaco salvia 159, struttura metallo antracite 160. Matt sage 159 lacquered top, anthracite 160 metal frame.



Piano laccato opaco smoke 128, struttura metallo smoke 128. Matt smoke 128 lacquered top, smoke 128 metal frame.



Piano materico nodato chiaro, struttura metallo antracite 160. Textured light knotted top, anthracite 160 metal frame.



Piano laccato opaco bianco gesso 121, struttura metallo pomice 152. Chalk white 121 lacquered top, pumice 152 metal frame.



Piano materico nodato scuro, struttura metallo antracite 160. Textured dark knotted top and anthracite 160 metal frame.



Piano in Hpl 11, struttura metallo antracite 160. HPL 11 top, anthracite 160 metal frame.



Tavolino Brigitte piano Hpl 11, struttura metallo hot 127. Ø 45 H 52 cm

Brigitte coffee table with HPL 11 top, hot grey 127 metal frame. Ø 45 H 52 cm



## BRIGITTE

misure / size    Ø 45 H 52 cm    Ø 100 H 30 cm

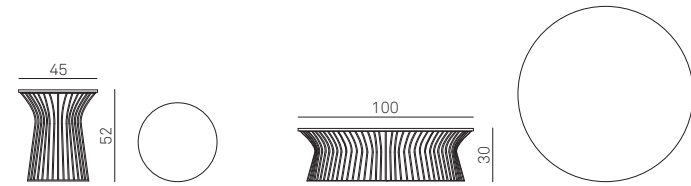

### FINITURE BASAMENTO / BASE FINISHES



### FINITURE PIANO / TOP FINISHES

#### MATERICO ESSENZA / TEXTURED WOOD



#### MATERICO NODATO / KNOTTED TEXTURED

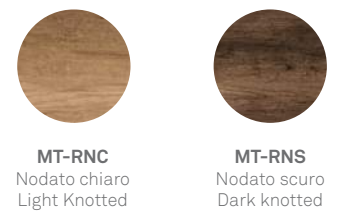

#### MATERICO PORO APERTO / OPEN PORE MATERIC



#### HPL



#### MATERICO / TEXTURED



#### MATERICO OPACO / MATT MATERIC

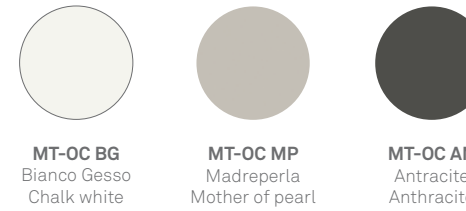

#### LEGNO LACCATO PORO APERTO / OPEN-PORE LACQUERED WOOD

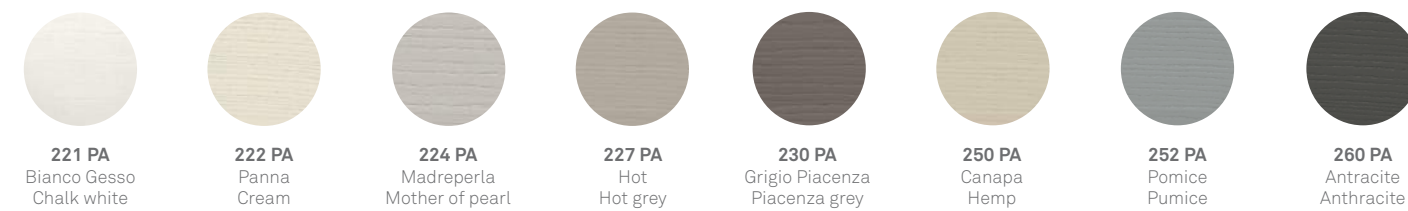

#### LACCATI / LACQUERS

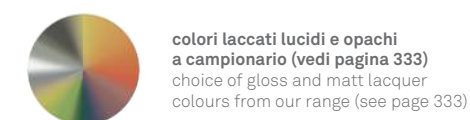

Tavolini Brigitte  
01. laccato opaco hot 127.  
Ø 45 H 52 cm

02. piano materico cemento scuro,  
struttura metallo antracite 160.  
Ø 45 H 52 cm

03. laccato opaco bianco gesso 121.  
Ø 100 H 30 cm

04. laccato opaco rosso 134.  
Ø 45 H 52 cm

Brigitte coffee tables  
01. matt hot grey 127 lacquer.  
Ø 45 H 52 cm

02. textured dark cement top,  
anthracite 160 metal frame.  
Ø 45 H 52 cm

03. matt chalk white 121 lacquer.  
Ø 100 H 30 cm

04. matt 134 red lacquer.  
Ø 45 H 52 cm



STRIKE



A destra: tavolini Strike versione Glamour e White, a sinistra: tavolini Strike versione Natural

On the right: Glamour and White Strike coffee tables, on the left: Natural Strike coffee tables.



## STRIKE

misure / size L/W 80 P/D 40 H 28,4 cm L/W 80 P/D 80 H 28,4 cm  
L/W 120 P/D 40 H 28,4 cm L/W 120 P/D 120 H 28,4 cm

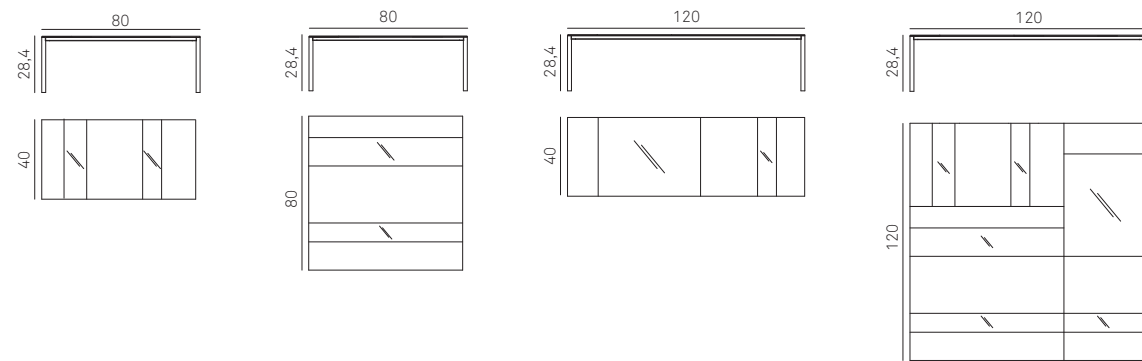

### NATURAL STYLE

FINITURE PIANO / TOP FINISHES



**MT-RNC**  
Nodato chiaro  
Light knotted



**VETRO/GLASS**  
hot 327  
hot grey 327

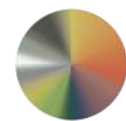

**metallo opaco a campionario (pag 333)**  
choice matt metal colours from our range (pag 333)

FINITURE STRUTTURA / BASE FINISHES

### GLAMOUR STYLE

FINITURE PIANO / TOP FINISHES



**PORO APERTO**  
hot 227  
hot grey 227



**VETRO/GLASS**  
smoke 328  
smoke 328

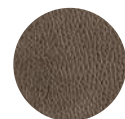

**MATERICO/TEXTURED MT-MB**  
Maya Bronze

FINITURE STRUTTURA / BASE FINISHES

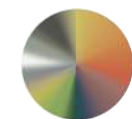

**metallo opaco a campionario (pag 333)**  
choice matt metal colours from our range (pag 333)

### WHITE STYLE

FINITURE PIANO / TOP FINISHES



**PA-BG**  
Bianco gesso  
Chalk white



**VETRO/GLASS**  
madreperla 324  
mother of pearl 324

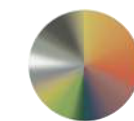

**metallo opaco a campionario (pag 333)**  
choice matt metal colours from our range (pag 333)

FINITURE STRUTTURA / BASE FINISHES

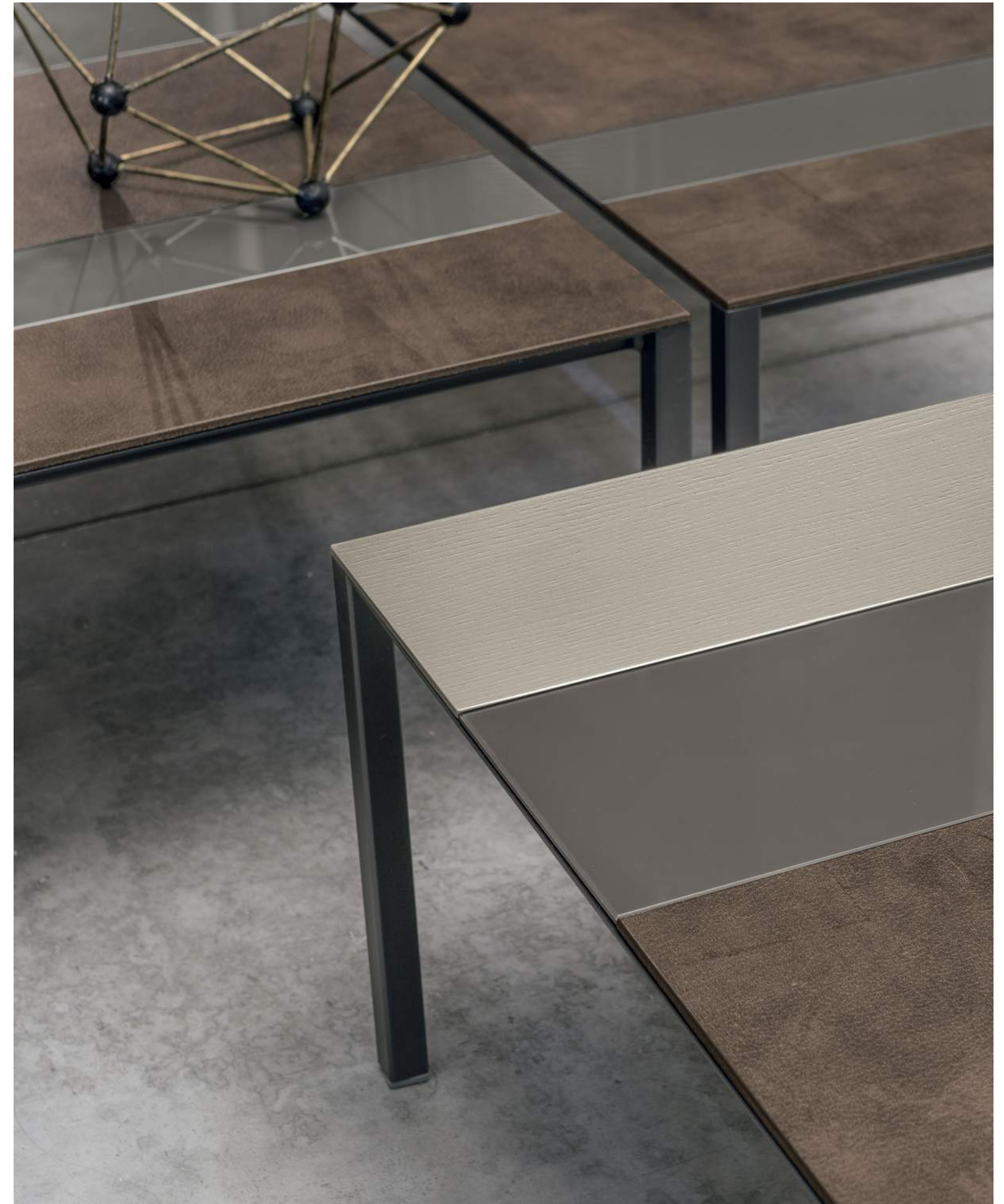





^  
**BLOOM**

Tavolini Bloom piano vetro  
trasparente 320, struttura legno  
rovere termocotto.  
Ø 41 H 62 cm  
Ø 56 H 47 cm

Wallpaper WPT534.

Bloom coffee tables with transparent  
320 glass top, heat-treated oak wood  
frame.  
Ø 41 H 62 cm  
Ø 56 H 47 cm

WPT534 wallpaper.

**BLOOM**

Tavolino Bloom piano vetro  
trasparente 320, struttura legno  
rovere termocotto.  
Ø 56 H 47 cm

Bloom coffee table with  
transparent 320 glass top, heat-  
treated oak wood frame.  
Ø 56 H 47 cm







Tavolino Bloom piano vetro trasparente 320, struttura legno rovere termocotto. L 120 P 120 H 40 cm

Bloom coffee table with transparent 320 glass top, heat-treated oak wood frame. L 120 W 120 H 40 cm

## BLOOM

misure / size    Ø 41 H 62 cm    Ø 56 H 47    L/W 110 P/D 60 H 40    L/W 120 P/D 120 H 40

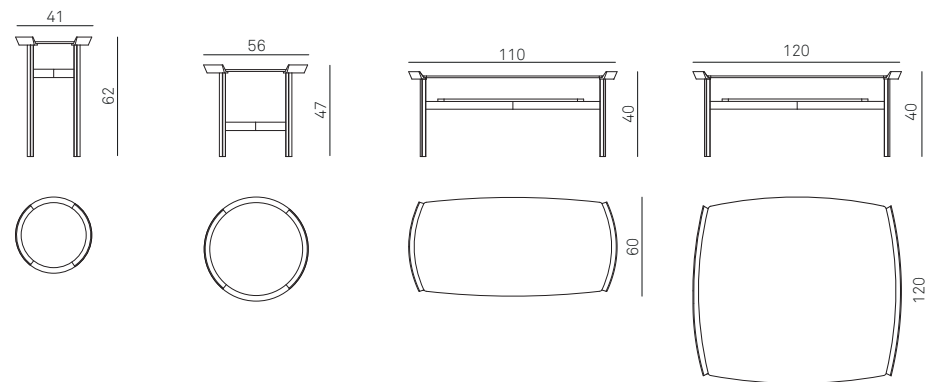

### FINITURE STRUTTURA / STRUCTURE FINISHES

ESSENZE / WOOD FINISHES



**LGN-FO**  
Frassino Oriente  
Eastern Ash



**LGN-RT**  
Rovere termocotto  
Heat-treated Oak

### FINITURA PIANO / TOP FINISHES



**320**  
Vetro trasparente  
Transparent glass



Tavolino Bloom piano vetro trasparente 320, struttura legno rovere termocotto. L 110 P 60 H 40 cm

Quadri Elegance Style XS.

Bloom coffee table with transparent 320 glass top, heat-treated oak wood frame. L 110 W 60 H 40 cm

Style XS Elegance Quadri.



FLEXO



Tavolino Flexo piano laccato opaco smoke 128, piano grande laccato opaco bianco gesso 121, struttura metallo bianco gesso 121.

Flexo coffee table in matt smoke 128 lacquer, large top in matt chalk white 121 lacquer, chalk white 121 metal frame.



## FLEXO E SENZATEMPO

misure / size  
**Flexo 90:** L/W 90 P/D 75 H 27 cm  
**Flexo 130:** L/W 130 P/D 75 H 27 cm  
**Flexo componibile / Modular Flexo:** L/W 210 (130+90) P/D 75 H 30,5 cm  
**Senzatempo:** L/W 120 P/D 60 H 27 cm

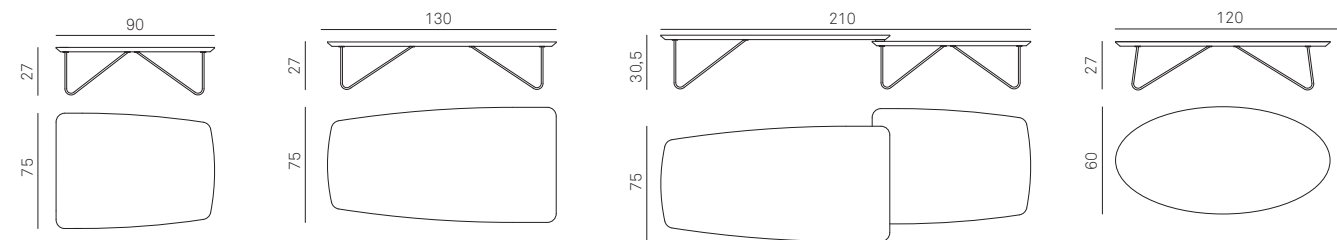

### FINITURE BASAMENTO / BASE FINISHES

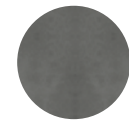

**DI SERIE / STANDARD**  
 Finitura Peltro  
 Pewter finish



**DI SERIE / STANDARD**  
 Finitura Antracite  
 Anthracite finish



**colori laccati opachi a campionario**  
 (vedi pagina 333)  
 choice of matt lacquer colours from  
 our range (see page 333)

### FINITURE PIANO / TOP FINISHES

LEGNO LACCATO PORO APERTO / OPEN-PORE LACQUERED WOOD



**221 PA**  
 Bianco Gesso  
 Chalk white



**222 PA**  
 Panna  
 Cream



**224 PA**  
 Madreperla  
 Mother of pearl



**227 PA**  
 Hot  
 Hot grey



**230 PA**  
 Grigio Piacenza  
 Piacenza grey



**250 PA**  
 Canapa  
 Hemp

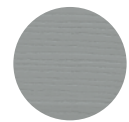

**252 PA**  
 Pomice  
 Pumice

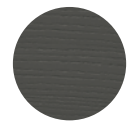

**260 PA**  
 Antracite  
 Anthracite

### LACCATI / LACQUERS

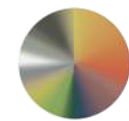

**colori laccati lucidi e opachi**  
**a campionario (vedi pagina 333)**  
 choice of gloss and matt lacquer  
 colours from our range (see page 333)



## FLEXO E SENZATEMPO

01. Tavolino Flexo laccato opaco hot  
 127.  
 L 90 P 75 H 27 cm

02. Tavolino Flexo piano laccato  
 opaco smoke 128, piano grande  
 laccato opaco bianco gesso 121,  
 struttura metallo bianco gesso 121.  
 L 130/90 P 75 H 30/27 cm

03. Tavolino Senzatempo  
 laccato opaco smoke 128.  
 L 120 P 60 H 27 cm

01. Matt hot grey 127 lacquered  
 Flexo coffee table.  
 L 90 W 75 H 27 cm

02. Flexo coffee table in matt  
 smoke 128 lacquer, large top in  
 matt chalk white 121 lacquer,  
 chalk white 121 metal frame.  
 L 130/90 W 75 H 30/27 cm

03. Senzatempo coffee table in  
 matt smoke 128 lacquer.  
 L 120 W 60 H 27 cm





Versione 10 laccato opaco bordeaux 156, pesca 157, antracite 160, madreperla 124.  
Option 10 matt lacquered finish in 156 burgundy, 157 peach, 160 anthracite, 124 mother-of-pearl.



Versione 11 laccato opaco salvia 159, blu avio 154, antracite 160, carta da zucchero 155.  
Option 11 matt lacquered finish in 159 sage, 154 air force blue, 160 anthracite, 155 blue grey.



Versione 12 laccato opaco antracite 160, pomice 152, bianco gesso 121.  
Option 12 matt lacquered finish in 160 anthracite, 152 pumice, 121 chalk white.



Versione 13 laccato opaco zafferano 158, smoke 128, arancio 148, verde muschio 153.  
Option 13 matt lacquered finish in 158 saffron, 128 smoke, 148 orange, 153 moss green.

misure / size      Ø 40 H 38 cm

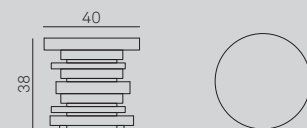

01. Tavolino 33 versione 11  
02. Tavolino 33 versione 13  
03. Tavolino 33 versione 12  
04. Tavolino 33 versione 10  
Ø 40 H 38 cm  
Wallpaper WPT 515.  
01. 33 coffee table, version 11.  
02. 33 coffee table, version 13.  
03. 33 coffee table, version 12.  
04. 33 coffee table, version 10.  
Ø 40 H 38 cm  
WPT 515 wallpaper.



# specchi

mirrors

Lineari e moderni, originali e insoliti per forma o materiale, gli specchi vanno scelti in sintonia con lo stile dell'ambiente e anche pensati per creare originali composizioni a parete.

Linear and modern, in original and unusual shapes or materials, mirrors should be chosen to suit the style of your home or arranged so as to create original wall compositions.







Uno specchio da posizionare senza una regola precisa, che porta sulla parete le forme e la magia delle bolle di sapone.

Mirrors you can position on the wall at will to conjure up some of the magical wonder of blowing bubbles.

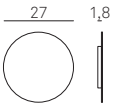
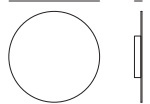
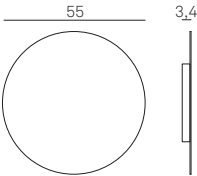
## BOLLE

misure / size	ø 27 P/D 1,8	ø 35 P/D 2,9	ø 55 P/D 3,4	finitura / finish
				 Specchio Mirror





Design allo specchio.  
Il pannello specchiato amplia l'ambiente,  
mentre gli inserti contenitori aumentano lo spazio.

Design through the looking glass.  
The mirrored panel makes the room look bigger,  
while the shelving inserts add extra storage space.

misure / size L/W 54 H 108/180 (pannello Inside specchio contenitori esclusi / Inside mirrored panel not including storage units)  
L/W 55 P/D 18 H 18 (elemento contenitore a giorno / open shelving unit)

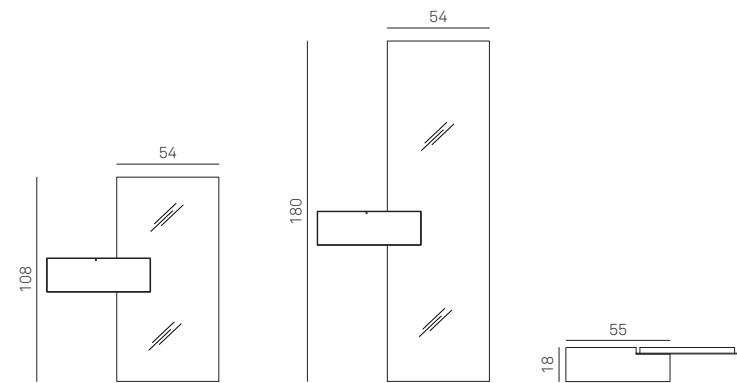

#### SPECCHIO / MIRROR



specchio argentato 381  
mirror 381

#### VANI A GIORNO / OPEN SHELVING

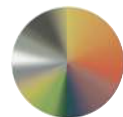

colori laccati opachi a campionario  
(vedi pagina 333)  
choice of matt lacquer colours from  
our range (see page 333)



Specchiera Inside  
vani a giorno metallo  
madreperla 124.  
L 54 P 18 H 180 cm

Kalista metallo  
antracite 160.  
L 27 P 36 H 80 cm

Inside mirror, mother  
of pearl 124 metal open  
shelving units.  
W 54 D 18 H 180 cm

Anthracite 160 metal  
Kalista element.  
W 27 D 36 H 80 cm



## HASHTAG

Specchiere Hashtag materico opaco bianco gesso, profilo laccato opaco bianco gesso 121, specchio argentato 381.

- 01. Tipo A L 65 H 125 SP - 3 cm
- 02. Tipo B L 65 H 65 SP - 3 cm
- 03. Tipo C L 100 H 72 SP - 3 cm
- 04. Tipo D L 65 H 180 SP - 3 cm

Hashtag mirrors in textured matt chalk white, matt chalk white 121 lacquered trims, silver 381 mirror.

- 01. W 65 H 125 - 3 cm thick
- 02. W 100 H 72 - 3 cm thick
- 03. W 65 H 65 - 3 cm thick
- 04. W 65 H 180 - 3 cm thick

01.



02.



03.



04.





## HASHTAG

misure / size L 65 H 65 SP 3 cm L 100 H 72 SP 3 cm L 65 H 125 SP 3 cm L 65 H 180 SP 3 cm

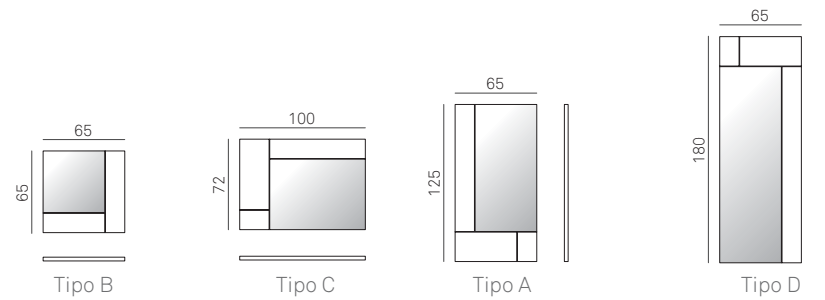

### SPECCHIO / MIRROR

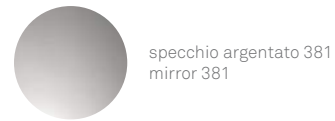

### PROFILO / PROFILE

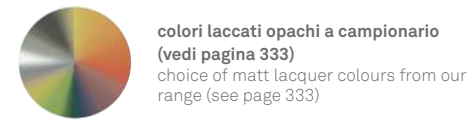

### CORNICE / FRAME

#### MATERICO NODATO / KNOTTED TEXTURED



#### MATERICO OPACO / MATT TEXTURED

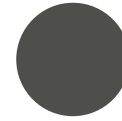
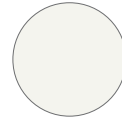

#### MATERICO / TEXTURED

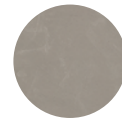
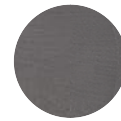

#### LACCATI / LACQUERS

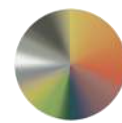



## VIP

misure / size L 101,8 H 66,9 SP 6 cm L 69,8 H 178,9 SP 6 cm

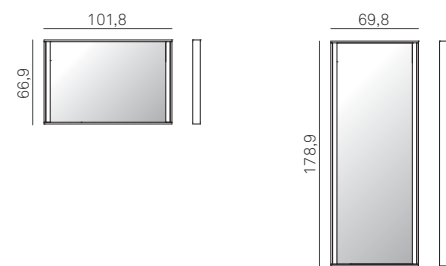

### SPECCHIO / MIRROR



specchio argentato 381  
silver mirror 381

### CORNICE / FRAME

#### ESSENZE / WOOD FINISHES



**LGN-FO**  
Frassino Oriente  
Eastern Ash



**LGN-RT**  
Rovere termocotto  
Heat-treated Oak

#### LEGNO LACCATO PORO APERTO / OPEN-PORE LACQUERED WOOD



**221 PA**  
Bianco Gesso  
Chalk white



**222 PA**  
Panna  
Cream



**224 PA**  
Madreperla  
Mother of pearl



**227 PA**  
Hot  
Hot grey



**230 PA**  
Grigio Piacenza  
Piacenza grey



**250 PA**  
Canapa  
Hemp

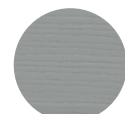

**252 PA**  
Pomice  
Pumice

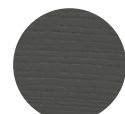

**260 PA**  
Antracite  
Anthracite

#### LACCATI / LACQUERS

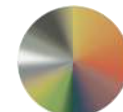

colori laccati opachi e  
lucidi a campionario  
(vedi pagina 333)  
choice of matt and glossy  
lacquer colours from our  
range (see page 333)



Specchiera Vip laccato poro aperto madreperla 224.  
L 101,8 H 66,9 SP - 6 cm

Vip mirror in open-pore mother of pearl 224 lacquer.  
W 101.8 H 66.9 - 6 cm thick



## DOLCEVITA

misure / size L 126 H 78 SP 6,5 cm

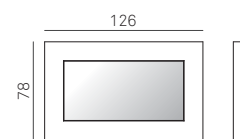

### SPECCHIO / MIRROR



specchio argentato 381  
mirror 381

### CORNICE / FRAME

#### ESSENZE / WOOD FINISHES



**LGN-FO**  
Frassino Oriente  
Eastern Ash



**LGN-RT**  
Rovere termocotto  
Heat-treated Oak

#### LEGNO LACCATO PORO APERTO / OPEN-PORE LACQUERED WOOD



**221 PA**  
Bianco Gesso  
Chalk white



**222 PA**  
Panna  
Cream



**224 PA**  
Madreperla  
Mother of pearl



**227 PA**  
Hot  
Hot grey



**230 PA**  
Grigio Piacenza  
Piacenza grey



**250 PA**  
Canapa  
Hemp

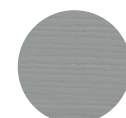

**252 PA**  
Pomice  
Pumice

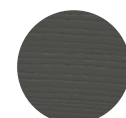

**260 PA**  
Antracite  
Anthracite

#### LACCATI / LACQUERS

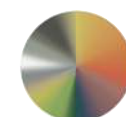

**colori laccati opachi e  
lucidi a campionario  
(vedi pagina 333)**  
choice of matt and glossy  
lacquer colours from our  
range (see page 333)



## DOLCEVITA

Specchiera Dolcevita legno laccato poro aperto  
bianco gesso 221.  
L 126 H 78 SP - 6,5 cm

Dolcevita mirror in open pore chalk white 121  
lacquered wood.  
W 126 H 78 - 6.5 cm thick



# accessori

accessories

Gli accessori arredano, decorano e valorizzano gli ambienti.  
Tanti oggetti e complementi per gli amanti dell'home style.

Accessories furnish, decorate and enhance your interiors.  
A wealth of homewares and occasional furniture for home style enthusiasts.







Kalista  
 01. metallo bianco gesso 121.  
 02. metallo antracite 160.  
 03. metallo salvia 159.  
 04. metallo zafferano 158.  
 05. metallo carta da zucchero 155.  
 06. metallo bordeaux 156.  
 L 27 P 36 H 80 cm  
 Wallpaper WPT 512.

Kalista  
 01. chalk white 121 metal.  
 02. anthracite 160 metal.  
 03. sage 159 metal.  
 04. saffron 158 metal.  
 05. blue grey 155 metal.  
 06. burgundy 156 metal.  
 W 27 D 36 H 80 cm  
 WPT 512 wallpaper.



Kalista metallo madreperla 124.  
 L 27 P 36 H 80 cm  
 Mother of pearl 124 metal Kalista.  
 W 27 D 36 H 80 cm





### KALISTA MIDI

Kalista Midi struttura  
metallo bianco gesso 121.  
L 60 P 40 H 160 cm

Kalista Midi with chalk  
white 121 metal frame.  
W 60 D 40 H 160 cm

### KALISTA

misure / size **Kalista:** L/W 27 P/D 36 H 80 cm **Kalista Midi:** L/W 60 P/D 40 H 160 cm **Kalista Fianco:** L/W 45 P/D 24 H 210 cm

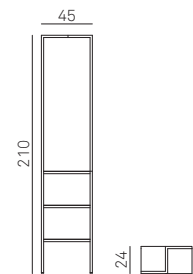
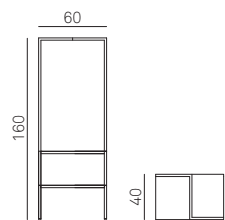
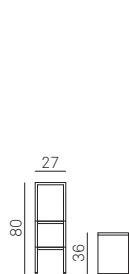

### FINITURE BASAMENTO / BASE FINISHES

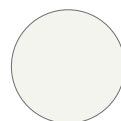

DI SERIE / STANDARD  
Bianco gesso 121  
White lacquered 121

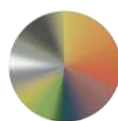

colori laccati opachi a campionario  
(vedi pagina 333)  
choice of matt lacquer colours from  
our range (see page 333)



### KALISTA FIANCO

Kalista Fianco struttura  
metallo bianco gesso 121.  
L 45 P 24 H 210 cm

Kalista Fianco side element  
with chalk white 121 metal frame.  
W 45 D 24 H 210 cm



Libreria Movida struttura metallo  
bianco gesso 121, ripiani materico  
nodato scuro.  
L 38 P 38 H 190 cm  
L 74 P 38 H 190 cm

Sedia Tiffany struttura legno laccato  
poro aperto antracite 260, rivestimento  
cat. b ecopelle vintage 107.  
L 46 P 50 H 83/47 cm

Pouf Comodo 03.  
L 85 P 85 H 85 cm

Movida bookcase with chalk white 121  
metal frame and textured dark knotted  
shelves.  
W 38 D 38 H 190 cm  
W 74 D 38 H 190 cm

Tiffany chair with wooden frame in open-  
pore anthracite 260 lacquer upholstered  
with cat. b vintage 107 eco-leather.  
W 46 D 50 H 83/47 cm

Comodo pouf 03.  
W 85 D 85 H 85 cm

## MOVIDA





## MOVIDA

misure / size

L/W 38 P/D 38 H 190

L/W 74 P/D 38 H 190

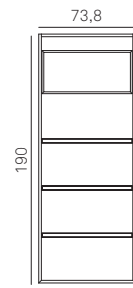
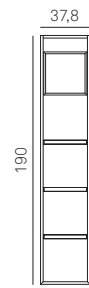

### FINITURE STRUTTURA / STRUCTURE FINISHES



**DI SERIE / STANDARD**  
Finitura Antracite  
Anthracite finish

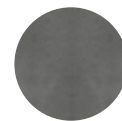

Finitura Peltro  
Pewter finish

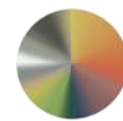

**colori laccati opachi a campionario**  
(vedi pagina 333)  
choice of matt lacquer colours from  
our range (see page 333)

### FINITURE PEDRO E RIPIANI / OPEN UNIT AND SHELF FINISHES

#### MATERICO NODATO / KNOTTED TEXTURED



**MT-RNC**  
Nodato chiaro  
Light Knotted



**MT-RNS**  
Nodato scuro  
Dark knotted

#### MATERICO ESSENZA / TEXTURED WOOD



**MT-FO**  
Frassino Oriente  
Eastern Ash



**MT-RT**  
Rovere termocotto  
Heat-treated Oak

#### MATERICO PORO APERTO / OPEN PORE TEXTURED



**MT-PA BG**  
Bianco Gesso  
Chalk white



**MT-PA MP**  
Madreperla  
Mother of pearl

#### MATERICO OPACO / MATT TEXTURED

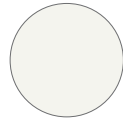

**MT-OC BG**  
Bianco Gesso  
Chalk white



**MT-OC MP**  
Madreperla  
Mother of pearl

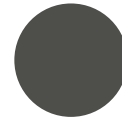

**MT-OC AN**  
Antracite  
Anthracite

#### MATERICO / TEXTURED



**MT-CC**  
Cemento chiaro  
Light cement



**MT-CS**  
Cemento scuro  
Dark cement

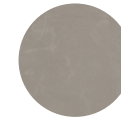

**MT-CV**  
Cemento cava  
Cava cement

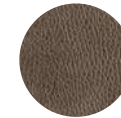

**MT-MB**  
Maya Bronze

#### LEGNO LACCATO PORO APERTO / OPEN-PORE LACQUERED WOOD



**221 PA**  
Bianco Gesso  
Chalk white



**222 PA**  
Panna  
Cream



**224 PA**  
Madreperla  
Mother of pearl



**227 PA**  
Hot  
Hot grey



**230 PA**  
Grigio Piacenza  
Piacenza grey



**250 PA**  
Canapa  
Hemp

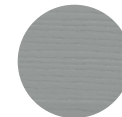

**252 PA**  
Pomice  
Pumice

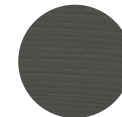

**260 PA**  
Antracite  
Anthracite

#### LACCATI / LACQUERS

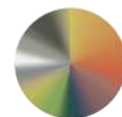

**colori laccati  
lucidi e opachi  
a campionario**  
(vedi pagina 333)  
choice of gloss and matt  
lacquer colours from  
our range  
(see page 333)



Libreria Movida struttura metallo antracite 160, ripiani materico nodato scuro.  
L 74 P 38 H 190 cm

Movida bookcase with anthracite 160 metal frame and textured dark knotted shelves.  
W 74 D 38 H 190 cm

Scrivania Raster piano materico nodato scuro, struttura metallo antracite 160.  
L 120 P 70 H 87 cm

Raster desk with textured dark knotted top and anthracite 160 metal frame.  
L 120 W 70 H 87 cm

Pouff Guccino cat. b econabuk 05, laccato opaco madreperla 124.  
Ø 40 H 53 cm

Guccino pouf in cat. b eco-nubuck 05 and matt mother of pearl 124 lacquer.  
Ø 40 H 53 cm



Raster  
vani a giorno orizzontali e verticali in  
molteplici combinazioni di colore.  
Raster orizzontale: L 144 P 30,5 H 18 cm  
Raster verticale: L 18 P 30,5 H 144 cm

Raster  
horizontal and vertical open shelving  
units in lots of colour combinations.  
Horizontal raster: W 144 D 30.5 H 18 cm  
Vertical raster: W 18 D 30.5 H 144 cm

RASTER





## RASTER

misure / size Raster orizzontale / horizontal: L/W 144 P/D 30,5 H 18 cm  
 Raster verticale / vertical: L/W 18 P/D 30,5 H 144 cm

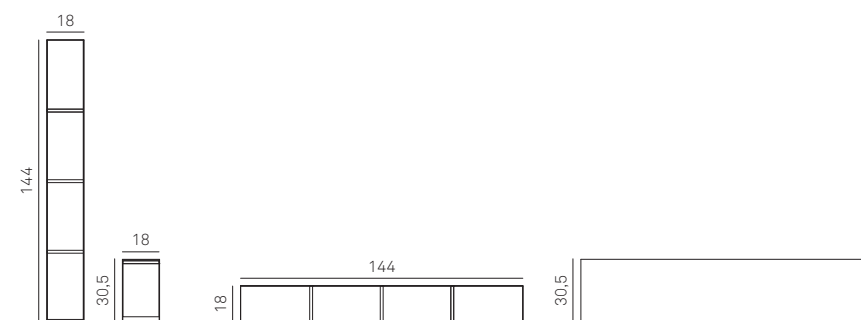

### FINITURE STRUTTURA / STRUCTURE FINISHES

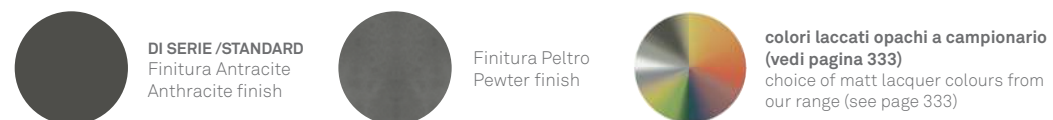

### FINITURE PEDRO E RIPIANI / OPEN UNIT AND SHELF FINISHES

#### MATERICO NODATO / KNOTTED TEXTURED



**MT-RNC**  
Nodato chiaro  
Light Knotted



**MT-RNS**  
Nodato scuro  
Dark knotted

#### MATERICO ESSENZA / TEXTURED WOOD



**MT-FO**  
Frassino Oriente  
Eastern Ash



**MT-RT**  
Rovere termocotto  
Heat-treated Oak

#### MATERICO PORO APERTO / OPEN PORE TEXTURED

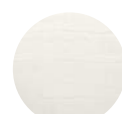

**MT-PA BG**  
Bianco Gesso  
Chalk white



**MT-PA MP**  
Madreperla  
Mother of pearl

#### MATERICO OPACO / MATT TEXTURED



**MT-OC BG**  
Bianco Gesso  
Chalk white



**MT-OC MP**  
Madreperla  
Mother of pearl



**MT-OC AN**  
Antracite  
Anthracite

#### MATERICO / TEXTURED



**MT-CC**  
Cemento chiaro  
Light cement



**MT-CS**  
Cemento scuro  
Dark cement

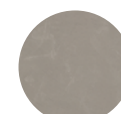

**MT-CV**  
Cemento cava  
Cava cement

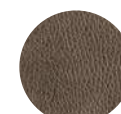

**MT-MB**  
Maya Bronze



**MT-INT C**  
Intreccio chiaro

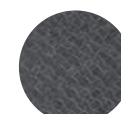

**MT-INT S**  
Intreccio scuro

#### LEGNO LACCATO PORO APERTO / OPEN-PORE LACQUERED WOOD



**221 PA**  
Bianco Gesso  
Chalk white



**222 PA**  
Panna  
Cream



**224 PA**  
Madreperla  
Mother of pearl



**227 PA**  
Hot  
Hot grey



**230 PA**  
Grigio Piacenza  
Piacenza grey



**250 PA**  
Canapa  
Hemp



**252 PA**  
Pomice  
Pumice



**260 PA**  
Antracite  
Anthracite

#### LACCATI / LACQUERS

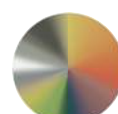

colori laccati opachi a campionario  
(vedi pagina 333)  
choice of matt lacquer colours  
from our range (see page 333)



Raster Sospesi struttura metallo antracite 160,  
inserti e schiena in materico frassino oriente.  
L 144 P 30 H 18 cm

Wall-hung Raster units with anthracite 160 metal  
structure and textured eastern ash  
inserts and back panels.  
W 144 D 30 H 18 cm



## RING

misure / size L/W 108 P/D 25,6 H 27,1 cm L/W 144 P/D 25,6 H 27,1 cm  
L/W162 P/D 25,6 H 27,1 cm L/W 180 P/D 25,6 H 27,1 cm

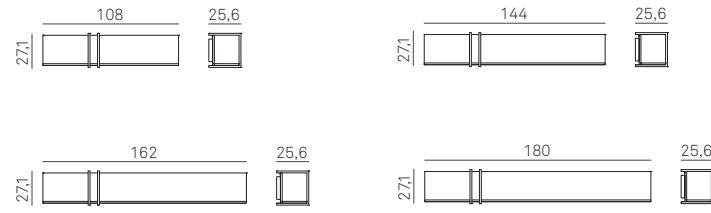

### FINITURE RING / RING FINISHES

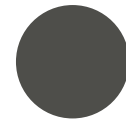

**DI SERIE / STANDARD**  
Finitura Antracite  
Anthracite finish

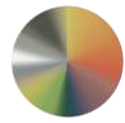

**colori laccati opachi a campionario**  
(vedi pagina 333)  
choice of matt lacquer colours from  
our range (see page 333)

### FINITURE STRUTTURA / STRUCTURE FINISHES

#### MATERICO NODATO / KNOTTED TEXTURED



**MT-RNC**  
Nodato chiaro  
Light Knotted



**MT-RNS**  
Nodato scuro  
Dark knotted

#### MATERICO ESSENZA / TEXTURED WOOD



**MT-FO**  
Frassino Oriente  
Eastern Ash



**MT-RT**  
Rovere termocotto  
Heat-treated Oak

#### MATERICO PORO APERTO / OPEN PORE TEXTURED



**MT-PA BG**  
Bianco Gesso  
Chalk white



**MT-PA MP**  
Madreperla  
Mother of pearl

#### MATERICO OPACO / MATT TEXTURED



**MT-OC BG**  
Bianco Gesso  
Chalk white



**MT-OC MP**  
Madreperla  
Mother of pearl



**MT-OC AN**  
Antracite  
Anthracite

#### MATERICO / TEXTURED



**MT-CC**  
Cemento chiaro  
Light cement



**MT-CS**  
Cemento scuro  
Dark cement



**MT-CV**  
Cemento cava  
Cava cement

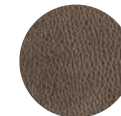

**MT-MB**  
Maya Bronze

#### LEGNO LACCATO PORO APERTO / OPEN-PORE LACQUERED WOOD



**221 PA**  
Bianco Gesso  
Chalk white



**222 PA**  
Panna  
Cream



**224 PA**  
Madreperla  
Mother of pearl



**227 PA**  
Hot  
Hot grey



**230 PA**  
Grigio Piacenza  
Piacenza grey



**250 PA**  
Canapa  
Hemp



**252 PA**  
Pomice  
Pumice

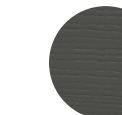

**260 PA**  
Antracite  
Anthracite

#### LACCATI / LACQUERS

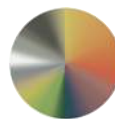

**colori laccati opachi a campionario**  
(vedi pagina 333)  
choice of matt lacquer colours from  
our range (see page 333)



## RING



Mensole Ring materico  
nodato chiaro,  
metallo bianco gesso 121.  
L 144 P 25,6 H 27,1 cm

Textured light knotted and  
chalk white 121 metal Ring  
shelves.  
L 144 D 25,6 H 27,1 cm



CIKO



Ciko varie combinazioni specchio, colori, finiture e grafiche.  
L 36 P 24 H 36 cm

Various combinations of Ciko including mirrors, colours, finishes and graphic design.  
W 36 D 24 H 36 cm



La schiena che decora.  
Come quadri, i contenitori con schiena in laccato, specchio  
o grafica animano la parete e si prestano per creare infinite  
composizioni e combinazioni.

The decorative back panel.  
Like pictures, these storage units liven up the wall with their  
lacquered, mirrored or graphic back panels and are perfect for  
mixing and matching in endless different compositions.

## CIKO

misure / size L/W 36 P/D 24 H 36 cm

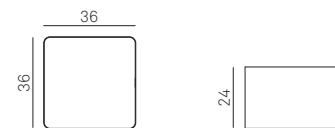

### FINITURE STRUTTURA / CARCASS FINISHES

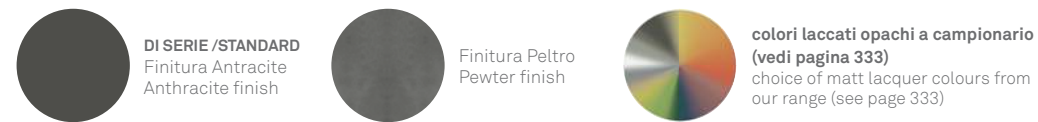

### COLORI E FINITURE SCHIENA / BACK FINISHES AND COLOURS

#### MATERICO NODATO / KNOTTED TEXTURED



**MT-RNC**  
Nodato chiaro  
Light Knotted

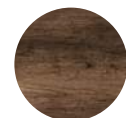

**MT-RNS**  
Nodato scuro  
Dark knotted

#### MATERICO ESSENZA / TEXTURED WOOD



**MT-FO**  
Frassino Oriente  
Eastern Ash



**MT-RT**  
Rovere termocotto  
Heat-treated Oak

#### MATERICO OPACO / MATT TEXTURED



**MT-OC BG**  
Bianco Gesso  
Chalk white



**MT-OC MP**  
Madreperla  
Mother of pearl



**MT-OC AN**  
Antracite  
Anthracite

#### MATERICO / TEXTURED



**MT-CC**  
Cemento chiaro  
Light cement



**MT-CS**  
Cemento scuro  
Dark cement



**MT-CV**  
Cemento cava  
Cava cement



**MT-MB**  
Maya Bronze



**MT-INT C**  
Intreccio chiaro

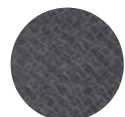

**MT-INT S**  
Intreccio scuro

#### MATERICO PORO APERTO / OPEN PORE TEXTURED



**MT-PA BG**  
Bianco Gesso  
Chalk white



**MT-PA MP**  
Madreperla  
Mother of pearl

#### LACCATI / LACQUERS

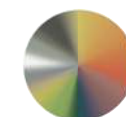

**colori laccati opachi a campionario**  
(vedi pagina 333)  
choice of matt lacquer colours from  
our range (see page 333)

#### SPECCHIO / MIRROR



Specchio  
Mirror

### GRAFICHE SCHIENA / BACK PANEL GRAPHIC DESIGNS



202



203



205



206



207



209



211



212



213



215



216



230



231



235



236



237



238



252

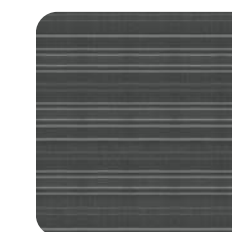

253



260





Pensili Petalo metallo bordeaux 156.  
L 60/80 H 22 P 18 cm  
Wallpaper WPT 536.

Burgundy 156 metal Petalo wall units.  
W 60/80 H 22 D 18 cm  
WPT 536 wallpaper.

## PETALO

misure / size L60 P18 H 22 cm DX e SX / RH and LH L80 P18 H 22 cm DX e SX / RH and LH

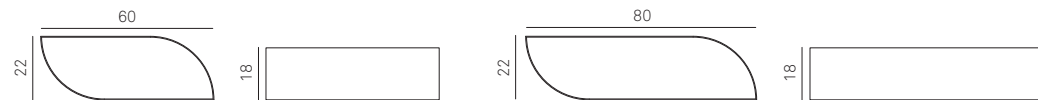

## FINITURE / FINISHES

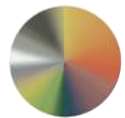

colori laccati opachi a campionario  
(vedi pagina 333)  
choice of matt lacquer colours from our  
range (see page 333)

## ESEMPI COMPOSIZIONI / EXAMPLES OF ARRANGEMENTS

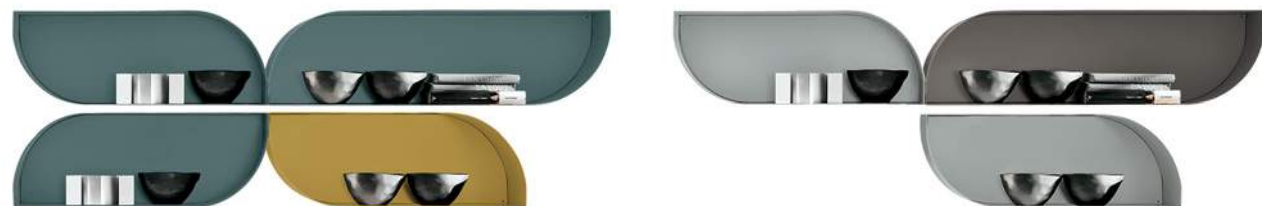

## PETALO

Pensili Petalo metallo salvia 159.  
L 60/80 H 22 P 18 cm  
Wallpaper WPT 550.

Sage 159 metal Petalo wall units.  
W 60/80 H 22 D 18 cm  
WPT 550 wallpaper.





Scrivania Atlante piano materico nodato  
chiaro, struttura metallo antracite 160.  
L 120 P 70 H 87 cm

Pouff Guccino cat. b econabuk 05,  
laccato opaco madreperla 124.  
Ø 40 H 53 cm

Atlante desk with textured light knotted top,  
anthracite 160 metal frame.  
L 120 W 70 H 87 cm

Guccino pouf in cat. b eco-nubuck 05 and matt  
mother of pearl 124 lacquer.  
Ø 40 H 53 cm



SCRITTOIO



Piano materico frassino oriente, struttura metallo antracite 160.  
Textured eastern ash top and anthracite 160 metal frame.



Piano materico nodato scuro, struttura metallo madreperla 124.  
Textured dark knotted top and mother of pearl 124 metal frame.



Piano materico cemento chiaro, struttura metallo antracite 160.  
Textured light cement top, anthracite 160 metal frame.



Piano laccato opaco salvia 159, struttura metallo antracite 160.  
Matt sage 159 lacquered top, anthracite 160 metal frame.



Scrivania laccata opaco  
bianco gesso 121.  
L 120 P 70 H 87 cm

Sedia Tiffany struttura legno  
laccato poro aperto bianco  
gesso 221, rivestimento cat. b  
ecopelle 34.  
L 46 P 50 H 83/47 cm  
Wallpaper WPT 507.

Desk in matt 121 chalk white  
lacquer.  
L 120 W 70 H 87 cm

Tiffany chair with wooden frame  
in open-pore chalk white 221  
lacquer upholstered with cat. b  
vintage 34 eco-leather.  
W 46 D 50 H 83/47 cm  
WPT 507 wallpaper.



## SCRITTOIO

misure / size L/W 120 P/D 70 H 87,7 cm

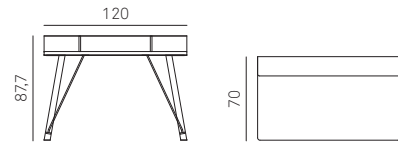

### FINITURE STRUTTURA E SCHIENA / STRUCTURE AND BACK FINISHES

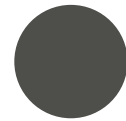

**DI SERIE / STANDARD**  
Finitura Antracite  
Anthracite finish



**DI SERIE / STANDARD**  
Finitura Peltro  
Pewter finish

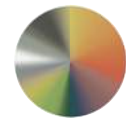

**colori laccati opachi a campionario**  
(vedi pagina 333)  
choice of matt lacquer colours from  
our range (see page 333)

### FINITURE PIANO E DIVISORI / TOP AND PARTITIONS FINISHES

#### MATERICO NODATO / KNOTTED TEXTURED



**MT-RNC**  
Nodato chiaro  
Light Knotted



**MT-RNS**  
Nodato scuro  
Dark knotted

#### MATERICO ESSENZA / TEXTURED WOOD



**MT-FO**  
Frassino Oriente  
Eastern Ash



**MT-RT**  
Rovere termocotto  
Heat-treated Oak

#### MATERICO PORO APERTO / OPEN PORE TEXTURED



**MT-PA BG**  
Bianco Gesso  
Chalk white



**MT-PA MP**  
Madreperla  
Mother of pearl

#### MATERICO OPACO / MATT TEXTURED

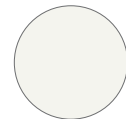

**MT-OC BG**  
Bianco Gesso  
Chalk white



**MT-OC MP**  
Madreperla  
Mother of pearl



**MT-OC AN**  
Antracite  
Anthracite

#### MATERICO / TEXTURED



**MT-CC**  
Cemento chiaro  
Light cement



**MT-CS**  
Cemento scuro  
Dark cement

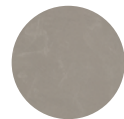

**MT-CV**  
Cemento cava  
Cava cement

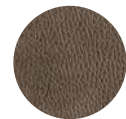

**MT-MB**  
Maya Bronze

#### LEGNO LACCATO PORO APERTO / OPEN-PORE LACQUERED WOOD



**221 PA**  
Bianco Gesso  
Chalk white



**222 PA**  
Panna  
Cream



**224 PA**  
Madreperla  
Mother of pearl



**227 PA**  
Hot  
Hot grey



**230 PA**  
Grigio Piacenza  
Piacenza grey



**250 PA**  
Canapa  
Hemp

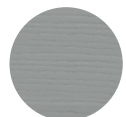

**252 PA**  
Pomice  
Pumice

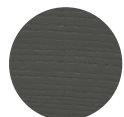

**260 PA**  
Antracite  
Anthracite

#### LACCATI / LACQUERS

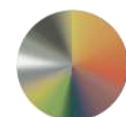

**colori laccati opachi a campionario**  
(vedi pagina 333)  
choice of matt lacquer colours from  
our range (see page 333)



Scrivania piano materico nodato chiaro,  
struttura metallo bianco gesso 121.  
L 120 P 70 H 87 cm

Raster Orizzontale struttura metallo  
bianco gesso 121, materico nodato chiaro.  
L 144 P 30 H 18 cm

Wallpaper WPT 527.

Desk with textured light knotted top,  
chalk white 121 metal frame.  
L 120 W 70 H 87 cm

Horizontal Raster unit in chalk white 121  
metal and textured light knotted finish.  
W 144 D 30 H 18 cm

WPT 527 wallpaper.





Panketta  
01. materico nodato scuro e  
struttura metallo bianco gesso 121.  
L 216 P 38 H 45 cm

02. laccato opaco bianco gesso 121.  
L 216 P 38 H 45 cm

03. materico nodato chiaro e  
struttura metallo antracite 160.  
L 144 P 38 H 45 cm

Panketta  
01. textured dark knotted top,  
chalk white 121 metal frame.  
L 216 W 38 H 45 cm

02. matt chalk white 121 lacquer.  
L 216 W 38 H 45 cm

03. textured light knotted and  
anthracite 160 metal frame.  
L 144 W 38 H 45 cm

01.

02.

03.



## PANKETTA

misure / size L/W 144 P/D 38 H 45 cm L/W 180 P/D 38 H 45 cm L/W 216 P/D 38 H 45 cm

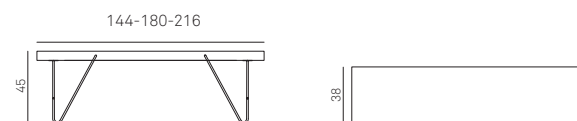

### FINITURE STRUTTURA E SCHIENA / STRUCTURE AND BACK FINISHES

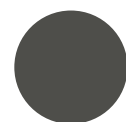

**DI SERIE / STANDARD**  
Finitura Antracite  
Anthracite finish



**DI SERIE / STANDARD**  
Finitura Peltro  
Pewter finish

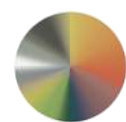

**colori laccati opachi a campionario**  
(vedi pagina 333)  
choice of matt lacquer colours from  
our range (see page 333)

### FINITURE PIANO E DIVISORI / TOP AND PARTITIONS FINISHES

#### MATERICO NODATO / KNOTTED TEXTURED



**MT-RNC**  
Nodato chiaro  
Light Knotted

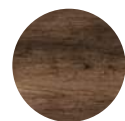

**MT-RNS**  
Nodato scuro  
Dark knotted

#### MATERICO ESSENZA / TEXTURED WOOD



**MT-FO**  
Frassino Oriente  
Eastern Ash



**MT-RT**  
Rovere termocotto  
Heat-treated Oak

#### MATERICO PORO APERTO / OPEN PORE TEXTURED



**MT-PA BG**  
Bianco Gesso  
Chalk white



**MT-PA MP**  
Madreperla  
Mother of pearl

#### MATERICO OPACO / MATT TEXTURED

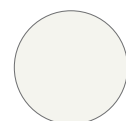

**MT-OC BG**  
Bianco Gesso  
Chalk white



**MT-OC MP**  
Madreperla  
Mother of pearl



**MT-OC AN**  
Antracite  
Anthracite

#### MATERICO / TEXTURED



**MT-CC**  
Cemento chiaro  
Light cement



**MT-CS**  
Cemento scuro  
Dark cement

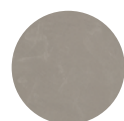

**MT-CV**  
Cemento cava  
Cava cement

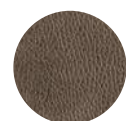

**MT-MB**  
Maya Bronze

#### LEGNO LACCATO PORO APERTO / OPEN-PORE LACQUERED WOOD



**221 PA**  
Bianco Gesso  
Chalk white



**222 PA**  
Panna  
Cream



**224 PA**  
Madreperla  
Mother of pearl



**227 PA**  
Hot  
Hot grey



**230 PA**  
Grigio Piacenza  
Piacenza grey



**250 PA**  
Canapa  
Hemp



**252 PA**  
Pomice  
Pumice



**260 PA**  
Antracite  
Anthracite

#### LACCATI / LACQUERS

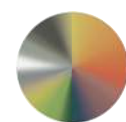

**colori laccati opachi a campionario**  
(vedi pagina 333)  
choice of matt lacquer  
colours from our range (see page 333)



Panketta materico nodato  
chiaro struttura metallo  
antracite 160.  
L 144 P 38 H 45 cm

Textured light knotted  
Panketta bench with  
anthracite 160 metal frame.  
L 144 W 38 H 45 cm





Tasca  
Sinistra: tessuto cat. b texas col. 25 e tasche in tessuto cat. b texas col. 12.  
Destra: tessuto cat. b texas col. 10 e tasche in tessuto cat. b texas col. 31.  
L 80 H 720 cm

Tasca  
Left: cat. B texas col. 25 fabric with pockets in cat. b texas col. 12 fabric  
Right: cat. B texas col. 10 fabric with pockets in cat. b texas col. 31 fabric  
W 80 H 720 cm

## TASCA

misure / size

**Tasca:** L/W 80 H 72 cm

**Tasca Fianco:** L/W 60 H 230 cm

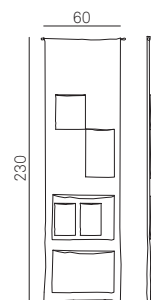
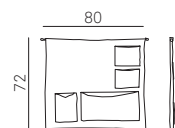

### RIVESTIMENTO / COVERING

**Econabuk, ecopelle e pelle**  
Eco-nubuck, eco-leather and leather upholstery



**Tessuti del campionario**  
Our range of fabrics



Tasca Fianco fondo in ecopelle vintage 102, tasche in ecopelle vintage 107.  
L 60 H 230 cm

Tasca Fianco for side panel: back in vintage 102 eco-leather, pockets in vintage 107 eco-leather.  
W 60 H 230 cm

## TASCA





## TOILETTE REPLAY

misure / size L/W 120 P/D 44 H 77 cm

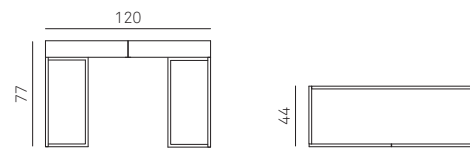

### FINITURE STRUTTURA / STRUCTURE FINISHES



**DI SERIE / STANDARD**  
Finitura Antracite  
Anthracite finish

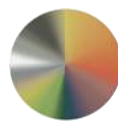

**colori laccati opachi a campionario**  
(vedi pagina 333)  
choice of matt lacquer colours  
from our range (see page 333)

### FINITURE TOP / TOP FINISHES



**vetro lucido colorato a campionario**  
(vedi pagina 334)  
choice of gloss coloured glass from our  
range (see page 334)

### FINITURE TOP E CASSETTI / TOP AND DRAWERS FINISHES

#### MATERICO ESSENZA / TEXTURED WOOD



**MT-FO**  
Frassino Oriente  
Eastern Ash



**MT-RT**  
Rovere termocotto  
Heat-treated Oak

#### MATERICO PORO APERTO / OPEN PORE TEXTURED



**MT-PA BG**  
Bianco Gesso  
Chalk white



**MT-PA MP**  
Madreperla  
Mother of pearl

#### MATERICO OPACO / MATT TEXTURED

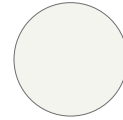

**MT-OC BG**  
Bianco Gesso  
Chalk white



**MT-OC MP**  
Madreperla  
Mother of pearl

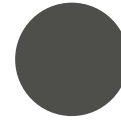

**MT-OC AN**  
Antracite  
Anthracite

#### MATERICO / TEXTURED



**MT-CC**  
Cemento chiaro  
Light cement



**MT-CS**  
Cemento scuro  
Dark cement

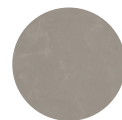

**MT-CV**  
Cemento cava  
Cava cement

#### LACCATI / LACQUERS

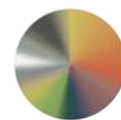

**colori laccati opachi a campionario**  
(vedi pagina 333)  
choice of matt lacquer colours  
from our range (see page 333)

#### LEGNO LACCATO PORO APERTO / OPEN-PORE LACQUERED WOOD



**221 PA**  
Bianco Gesso  
Chalk white



**222 PA**  
Panna  
Cream



**224 PA**  
Madreperla  
Mother of pearl



**227 PA**  
Hot  
Hot grey



**230 PA**  
Grigio Piacenza  
Piacenza grey



**250 PA**  
Canapa  
Hemp

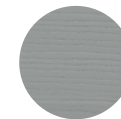

**252 PA**  
Pomice  
Pumice

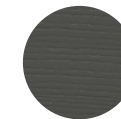

**260 PA**  
Antracite  
Anthracite

## TOILETTE



Toilette Replay piano materico  
rovere termocotto,  
struttura metallo antracite 160.  
L 120 P 44 H 77 cm

Pouf Cookie cat. c casale 100.  
L 46 P 47 H 47 cm

Wallpaper WPT 552.

Replay dressing table with  
textured heat-treated oak top and  
anthracite 160 metal frame.  
L 120 W 44 H 77 cm

Cookie pouf cat. c casale 100.  
W 46 D 47 H 47 cm

WPT 552 wallpaper.



La nuova frontiera delle mensole assume forme e combinazioni inedite per dare vita e personalità alle pareti.

Pushing the boundaries of shelving with never-before-seen shapes and combinations for lively walls full of personality.

## SHAPE

Composizione Shape 5B laccato opaco bianco gesso 121.

Tavolo Brigitte laccato opaco bianco gesso 121.  
Ø 120 H 75 cm.

Sedia Betty cat. b ecopelle extrema 01.  
L 45 P 54 H 81/46 cm.

Shape 5B arrangement in matt chalk white 121 lacquer.

Brigitte table in matt chalk white 121 lacquer.  
Ø 120 H 75 cm

Betty chair upholstered with cat. b extrema 01 eco-leather.  
W 45 D 54 H 81/46 cm.







## SHAPE

Shape composizione 1B  
materico nodato chiaro,  
laccato opaco madreperla 124,  
laccato opaco pesca 157.

Wallpaper WPT511.

Shape arrangement 1B in textured  
light knotted, matt mother of pearl  
124 lacquer and matt peach 157  
lacquer.

WPT511 wallpaper.

## SHAPE

Composizione Shape 5A, finitura  
peltro e materico opaco antracite.

Shape 05A arrangement in pewter  
finish and textured anthracite.

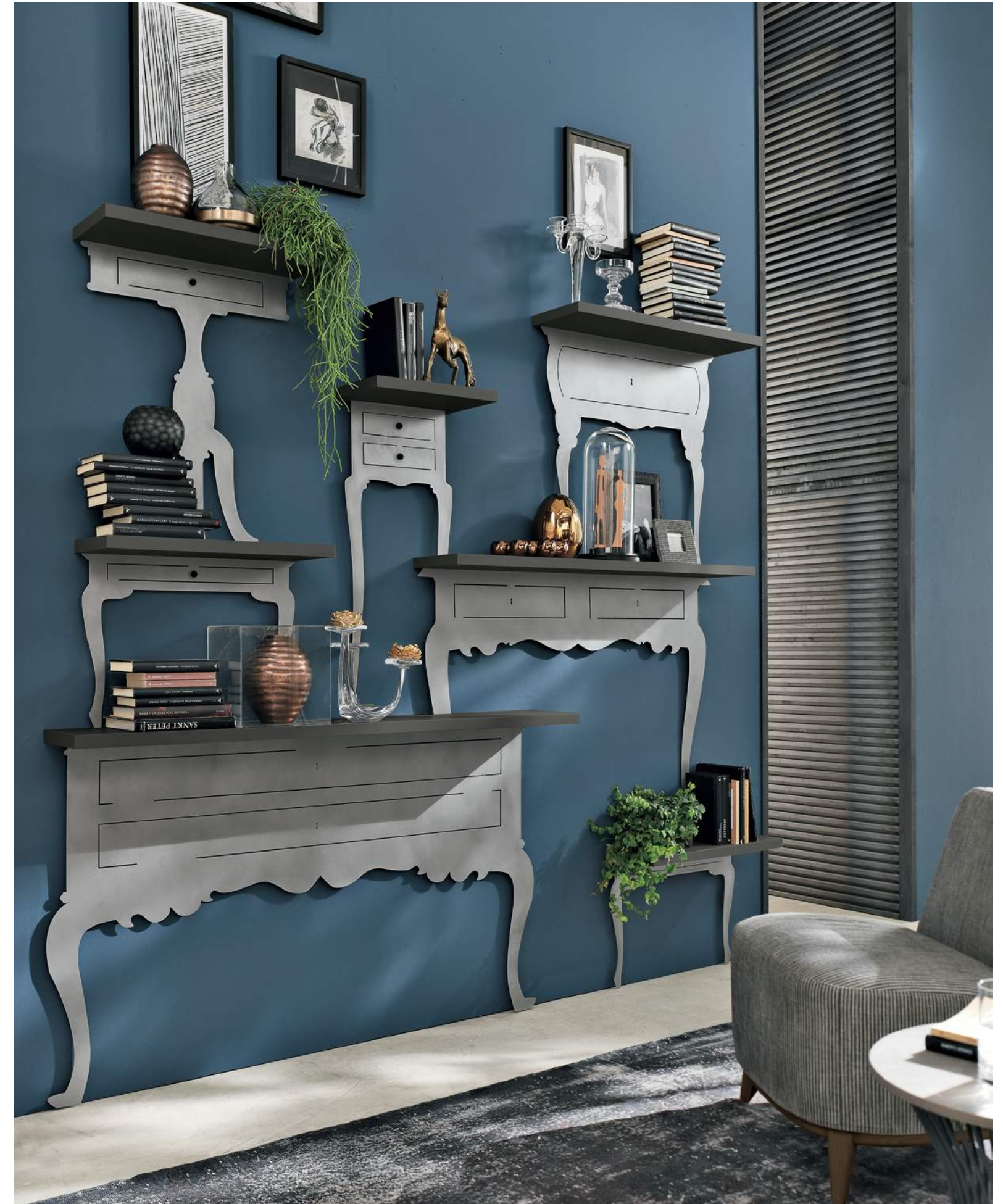



## SHAPE

misure / size

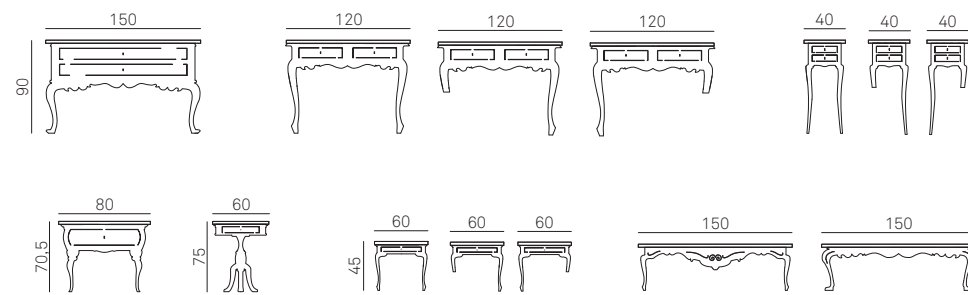

esempi composizioni / examples of arrangements

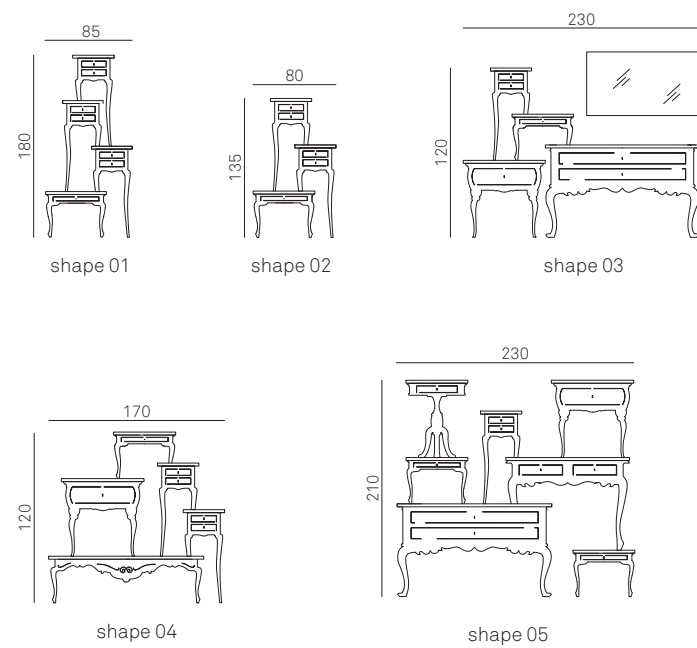

## FINITURE STRUTTURA / STRUCTURE FINISHES

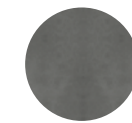

**DI SERIE / STANDARD**  
Finitura Peltro  
Pewter finish



**DI SERIE / STANDARD**  
Finitura Antracite  
Anthracite finish

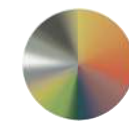

**colori laccati opachi a campionario**  
(vedi pagina 333)  
choice of matt lacquer colours from  
our range (see page 333)

## FINITURE MENSOLA / SHELF FINISHES

MATERICO ESSENZA / TEXTURED WOOD



**MT-FO**  
Frassino Oriente  
Eastern Ash



**MT-RT**  
Rovere termocotto  
Heat-treated Oak

MATERICO NODATO / KNOTTED TEXTURED

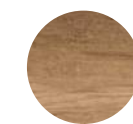

**MT-RNC**  
Nodato chiaro  
Light Knotted



**MT-RNS**  
Nodato scuro  
Dark knotted

MATERICO PORO APERTO / OPEN PORE TEXTURED



**MT-PA BG**  
Bianco Gesso  
Chalk white



**MT-PA MP**  
Madreperla  
Mother of pearl

MATERICO / TEXTURED



**MT-CC**  
Cemento chiaro  
Light cement



**MT-CS**  
Cemento scuro  
Dark cement

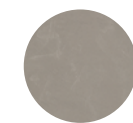

**MT-CV**  
Cemento cava  
Cava cement

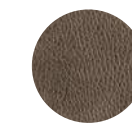

**MT-MB**  
Maya Bronze

MATERICO OPACO / MATT TEXTURED

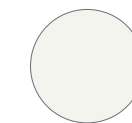

**MT-OC BG**  
Bianco Gesso  
Chalk white



**MT-OC MP**  
Madreperla  
Mother of pearl



**MT-OC AN**  
Antracite  
Anthracite

LEGNO LACCATO PORO APERTO / OPEN-PORE LACQUERED WOOD

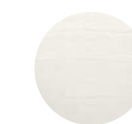

**221 PA**  
Bianco Gesso  
Chalk white



**222 PA**  
Panna  
Cream



**224 PA**  
Madreperla  
Mother of pearl



**227 PA**  
Hot  
Hot grey



**230 PA**  
Grigio Piacenza  
Piacenza grey



**250 PA**  
Canapa  
Hemp

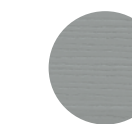

**252 PA**  
Pomice  
Pumice

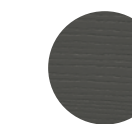

**260 PA**  
Antracite  
Anthracite

LACCATI / LACQUERS

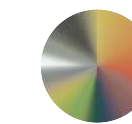

**colori laccati opachi a campionario**  
(vedi pagina 333)  
choice of matt lacquer colours  
from our range (see page 333)



## INGRESSI



Ingresso I02 materico rovere termocotto, laccato opaco bordeaux 156, laccato opaco madreperla 124, metallo antracite 160, specchio inside.  
I02 hall arrangement in textured heat-treated oak, matt burgundy 156 lacquer and matt mother of pearl 124 lacquer, anthracite 160 metal, inside mirror.



Ingresso I03 laccato opaco carta da zucchero 155, orologio 643, specchio inside.  
I03 hall arrangement in matt blue grey 155 lacquer, 643 clock, inside mirror.



Ingresso I04 materico cemento chiaro, laccato opaco bianco gesso 121, metallo antracite 160, Lettering, appendiabiti Me&You peltro, specchio inside.  
I04 hall arrangement in textured light cement, matt chalk white 121 lacquer, anthracite 160 metal, Lettering, pewter Me&You pegs, inside mirror.



Ingresso I05 materico frassino oriente, materico cemento chiaro, metallo salvia 159, specchio inside.  
I05 hall arrangement in textured frassino oriente, textured light cement, sage 159 lacquered metal, inside mirror.

## INGRESSI



Ingresso I01 laccato opaco madreperla 124, materico frassino oriente.  
Raster metallo antracite 160, inserti materico frassino oriente.  
L 180 P 30-40 H 234 cm  
Pouff Cookie cat. c linara 02, filo rosso 0856.  
Specchio Bolle. Ø 27-35-55.  
Orologio 630.

I01 hall arrangement in matt mother of pearl 124 lacquer and textured eastern ash.  
Anthracite 160 metal Raster unit, textured eastern ash inserts.  
W 180 D 30-40 H 234 cm  
Cookie pouf cat. c linara 02, red 0856 yarn.  
Bolle mirror Ø 27-35-55.  
630 clock.





## UP&DOWN

Un'altalena per volare sempre più in alto nel design. Può essere utile, come comodino o piano d'appoggio, ma anche semplicemente bella da vedere.

A swing takes design to new heights. It can be useful - as a bedside table or handy shelf - or just be beautiful to look at.

misure / size

L/W 60 P/D 30 cm

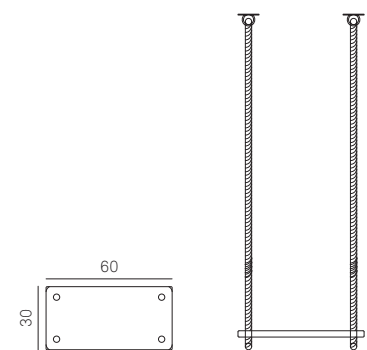

FINITURE / FINISHES



Rovere Nodato naturale  
Natural knotted oak



Rovere Bianco spazzolato  
Brushed white oak



UP&DOWN

Up&Down rovere nodato naturale.

Pouf Giglio cat. 1/one point 06,  
cat.b ecopelle vintage 103.  
L 85 P 85 H 30 cm

Up&Down natural knotted oak

Giglio floor cushion in cat. 1/one point  
06 and cat. b vintage 103 eco-leather.  
W 85 D 85 H 30 cm



Un elemento irrinunciabile per chi non vuole perdere tempo.  
 Gli orologi da parete interpretano un classico dell'arredo  
 con estrema originalità.

A must-have for all those who always finds time for good design.  
 These clocks are an extremely original take on a classic piece.



misure / size

Ø 45

45

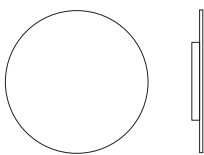

sp. 2,1 cm base metallo / 2.1 cm thick metal finish  
 sp. 3,3 cm base rovere nodato chiaro / 3.3 cm thick light knotted oak finish

## CLOCK

Clock collection 9 grafiche  
 diverse per personalizzare  
 l'orologio da parete.  
 ø 45 - spessore 3,3 cm

Clock collection: 9 different  
 graphic designs to customise  
 your wall clock.  
 ø 45 - 3.3 cm thick





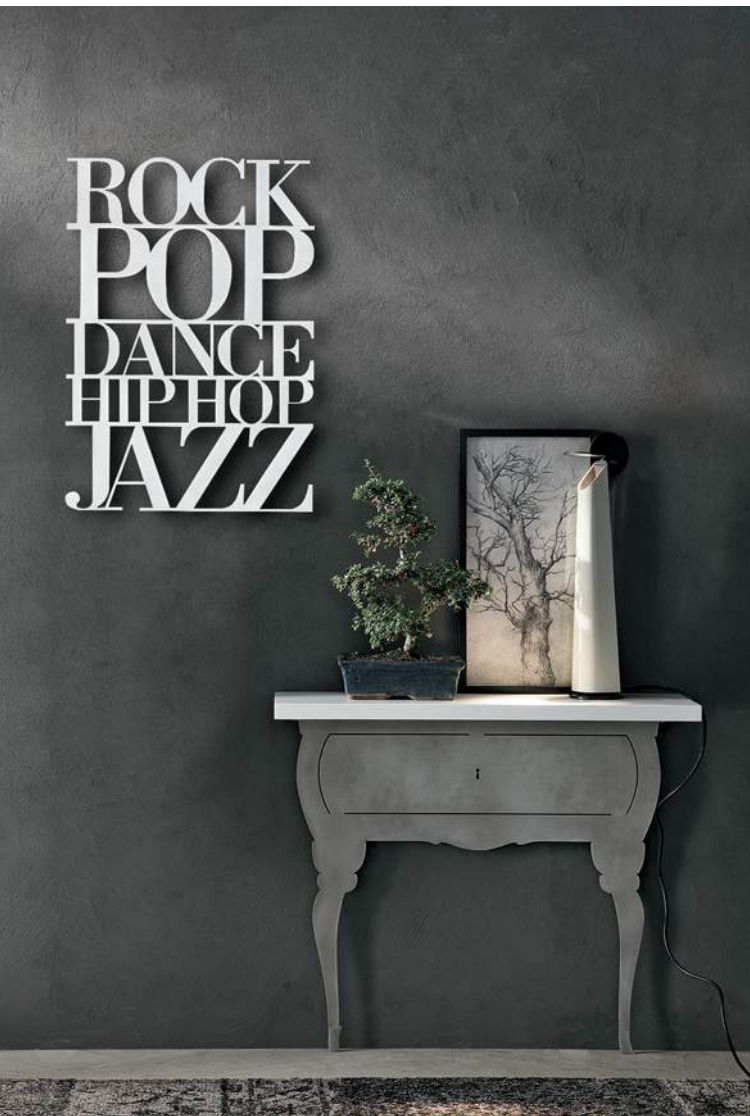

Lettering Music metallo bianco gesso 121.  
Chalk white 121 metal Music Lettering.

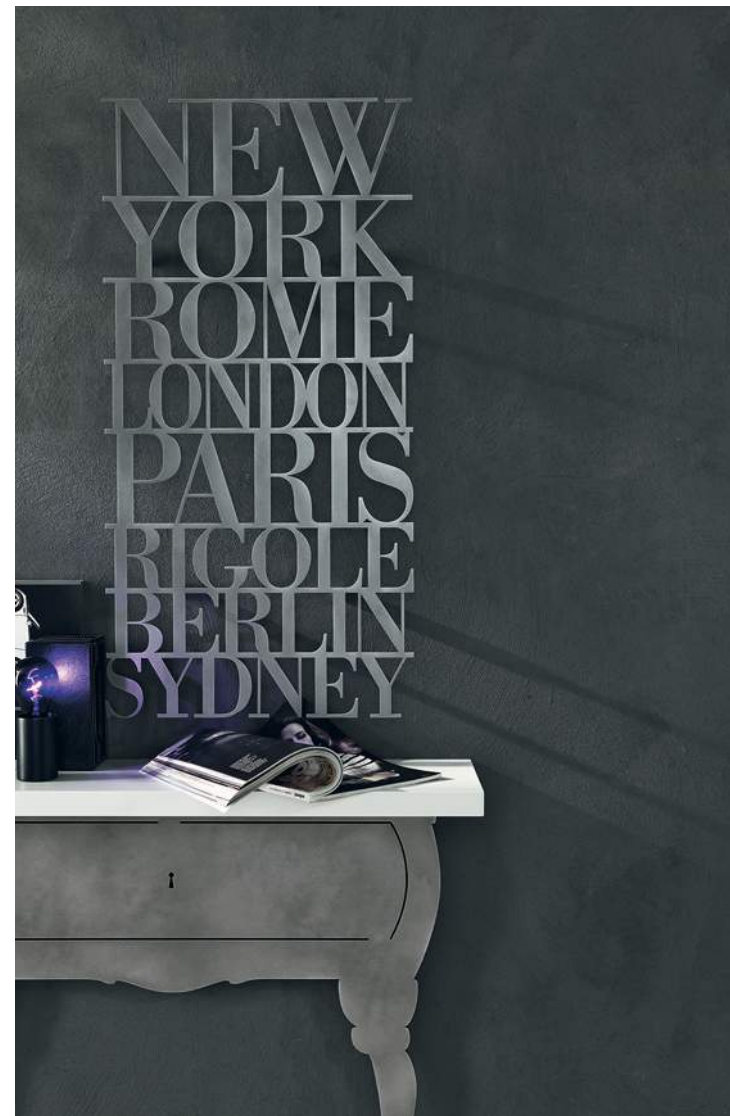

Lettering City peltro.  
Pewter finish City Lettering.

## LETTERING

misure / size

**me&you** : L 100 H 19,2 cm

**music**: L 42 H 60 cm

**city**: L 42 H 80 cm

appendiabiti/coat pegs



## FINITURE STRUTTURA / FRAME FINISHES



Peltro  
Pewter



Antracite 160  
Anthracite 160



Bianco Gesso 121  
Chalk white 121



## LETTERING

Lettering Me&You metallo antracite 160.  
Me&You Lettering in anthracite 160 metal.



Elegance Style XS



ingombro totale / total L. 71 cm

ingombro totale / total H. 75 cm

Elegance Style S



ingombro totale / total L. 87 cm

ingombro totale / total H. 87 cm

Elegance Style M



ingombro totale / total L. 120 cm

ingombro totale / total H. 127 cm



Elegance Style L  
ingombro totale L. 201 H. 184 cm



Natural Style XS

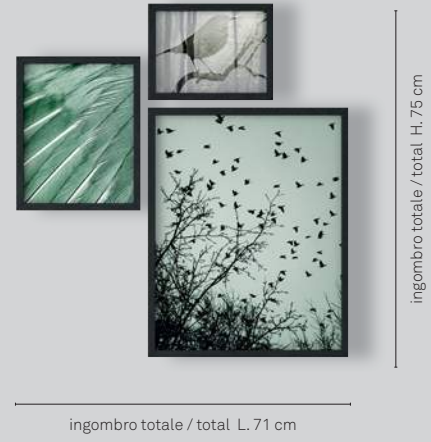

Natural Style S



Natural Style M





Colours Style XS



ingombro totale / total L. 71 cm

Colours Style S



ingombro totale / total L. 87 cm

Colours Style M

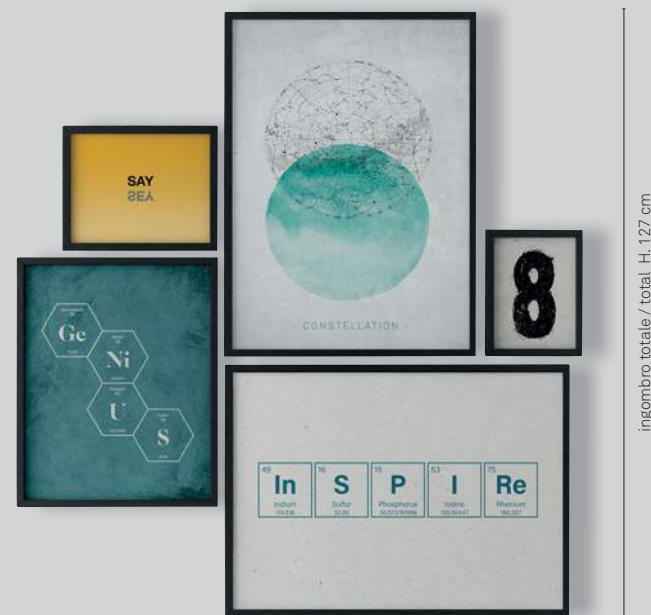

ingombro totale / total L. 120 cm



Colours Style L  
ingombro totale L. 201 H. 184 cm



Contemporary Style XS



ingombro totale / total L. 71 cm

ingombro totale / total H. 75 cm

Contemporary Style S



ingombro totale / total L. 87 cm

ingombro totale / total H. 87 cm

Contemporary Style M



ingombro totale / total L. 120 cm

ingombro totale / total H. 127 cm



Contemporary Style L  
ingombro totale L. 231 H. 107 cm



Loft Style S



ingombro totale / total H. 87 cm

ingombro totale / total L. 50 cm

Loft Style M



ingombro totale / total H. 87 cm

ingombro totale / total L. 107 cm

Loft Style L



ingombro totale / total H. 134 cm

ingombro totale / total L. 107 cm



Loft Style L  
ingombro totale L. 107 H. 134 cm



# TAPPETI

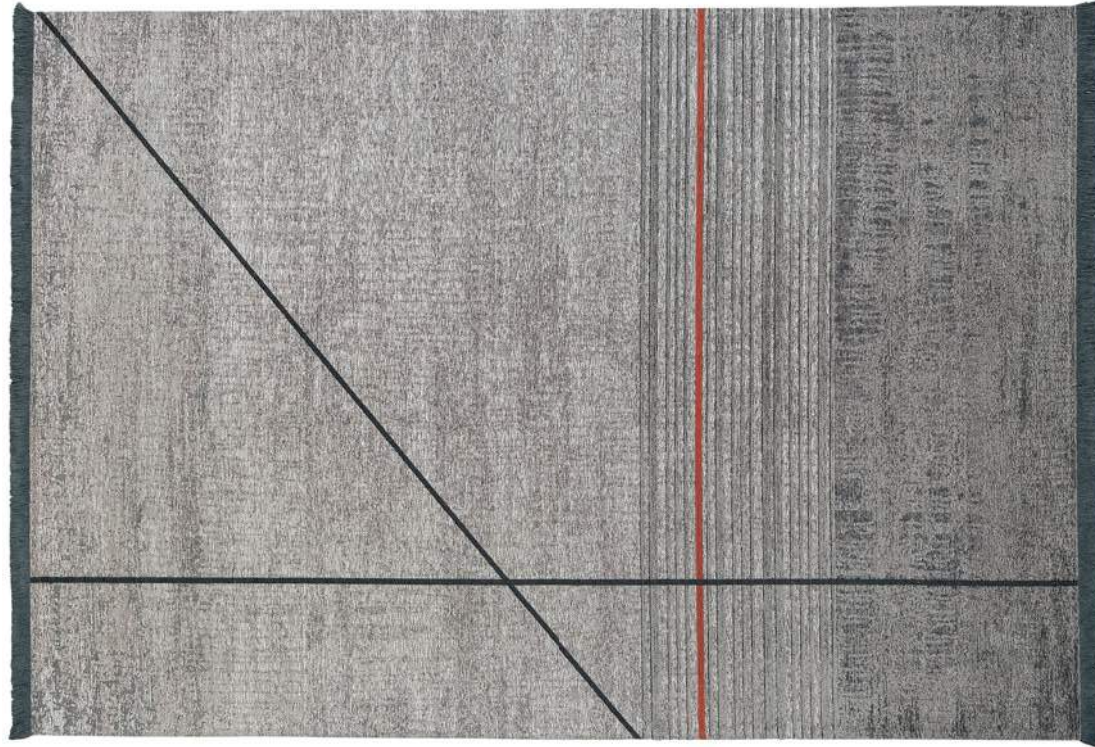

Tappeto/rug Diagonal.  
L 200 P 300 cm

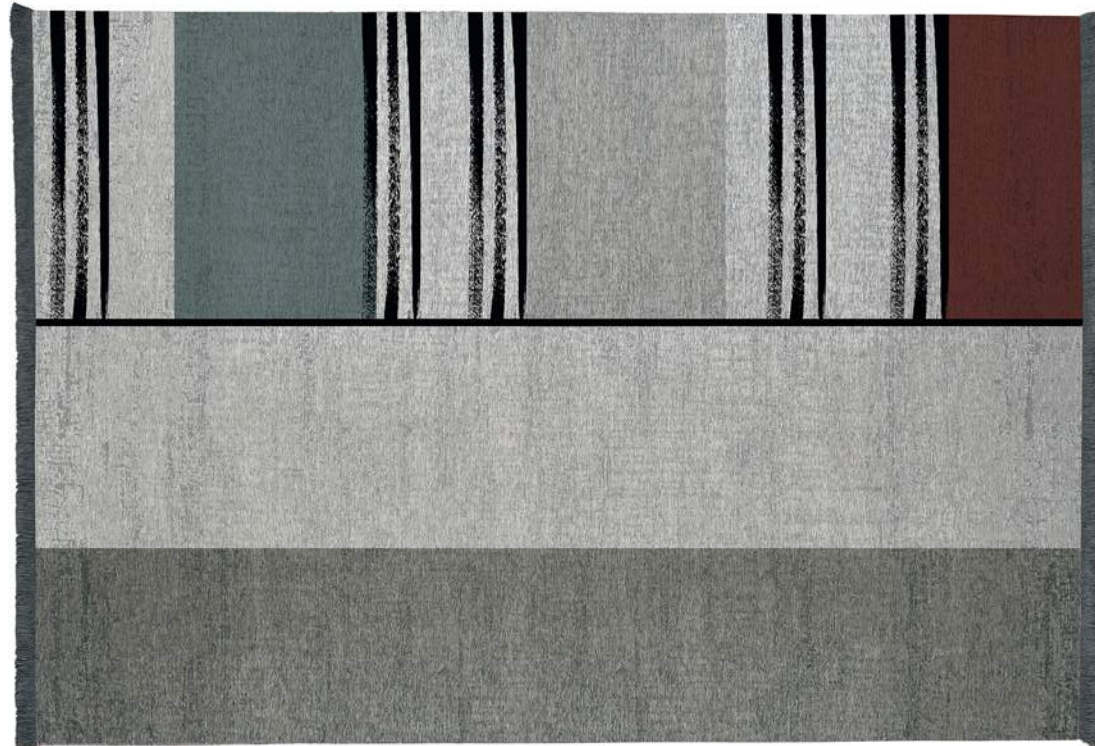

Tappeto/rug Stripes.  
L 200 P 300 cm



Tappeto Diagonal.  
L 200 P 300 cm



# TAPPETI

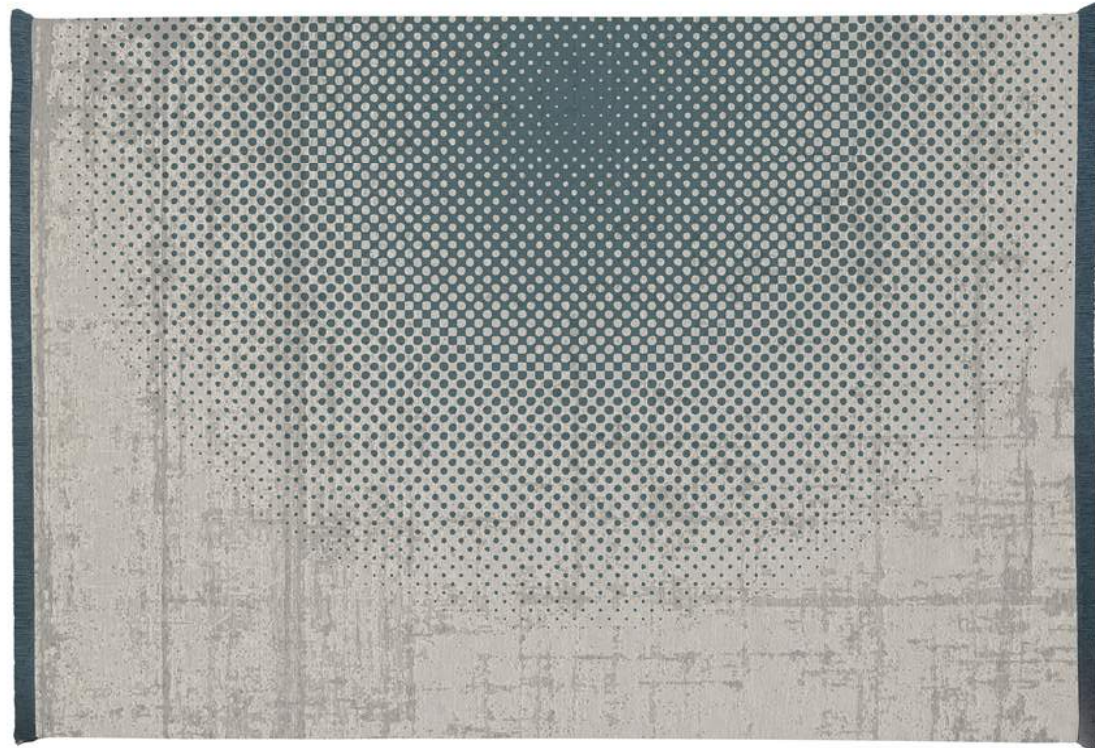

Tappeto/rug Dots.  
L 200 P 300 cm



Tappeto/rug Gradient.  
L 200 P 300 cm





# TAPPETI

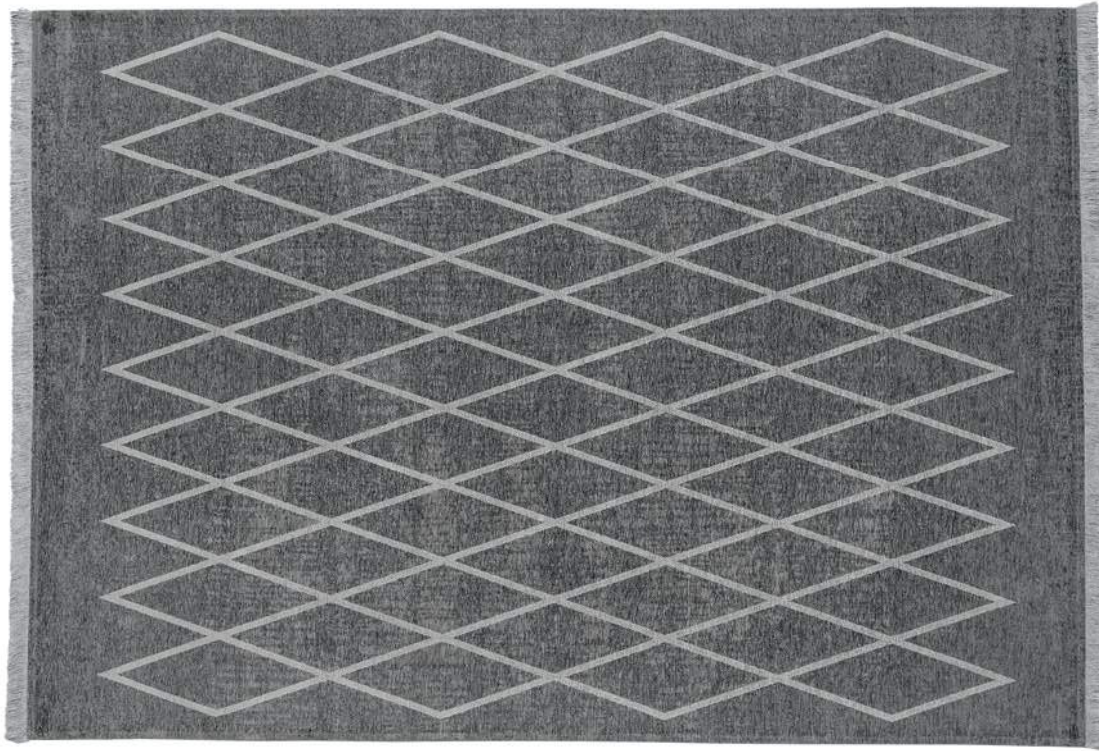

Tappeto/rug Frame.  
L 200 P 300 cm



Tappeto/rug Black & White.  
L 200 P 300 cm



Tappeto Stripes.  
L 200 P 300 cm





Dopo la camera da letto, le coperte conquistano anche il living. Leggeri e delicati, tinta unita o colorati, i plaid scaldano e decorano sia la notte, sia il giorno.

Throws are venturing out of the bedroom and into the living room. Light and delicate, plain or colourful, throws bring warmth and a decorative touch to your days and nights.

01. Plaid Lino Sacco  
misure 150x195 cm.

02. Plaid Militare  
misure 150x195 cm.

03. Plaid Cuzco  
misure 150x195 cm.

01. Plaid Lino Sacco  
misure 150x195 cm.

02. Plaid Militare  
misure 150x195 cm.

03. Plaid Cuzco  
misure 150x195 cm.



01.

02.

03.



Non solo un complemento d'arredo ma il fulcro della decorazione della zona giorno e notte. gioca con diversi tessuti, forme e confezioni per creare il giusto mood per un ambiente di tendenza.

Cushions can be more than accessories: they can determine the decorative style of the day and night areas. mix and match various fabrics, shapes and styles to create the right mood for a trendy setting.

Formati / Sizes

Cod. 64480  
L. 40 P. 40 cm



Cod. 64481  
L. 55 P. 55 cm



Cod. 64484  
L. 50 P. 25 cm



Cod. 64485  
L. 65 P. 35 cm



Tipi di confezione / Styles

Confezione/Style 01



Confezione/Style 02



Confezione/Style 03



Confezione/Style 04



Confezione/Style 06



Confezione/Style 08



Colori Fili Cuciture / Colours, yarns, seams

 Cod. 0587	 Cod. 0338	 Cod. 5054	 Cod. 0020
 Cod. 0133	 Cod. 3286	 Cod. 0856	 Cod. 3426
 Cod. 0209	 Cod. 5017	 Cod. 2851	 Cod. 0877
 Cod. 0128			



CUSCINI





Collezione Wallpaper, tanti soggetti per decorare con creatività le pareti.

Wallpaper collection, plenty of designs for decorating walls creatively.

## WALLPAPER COLLECTION

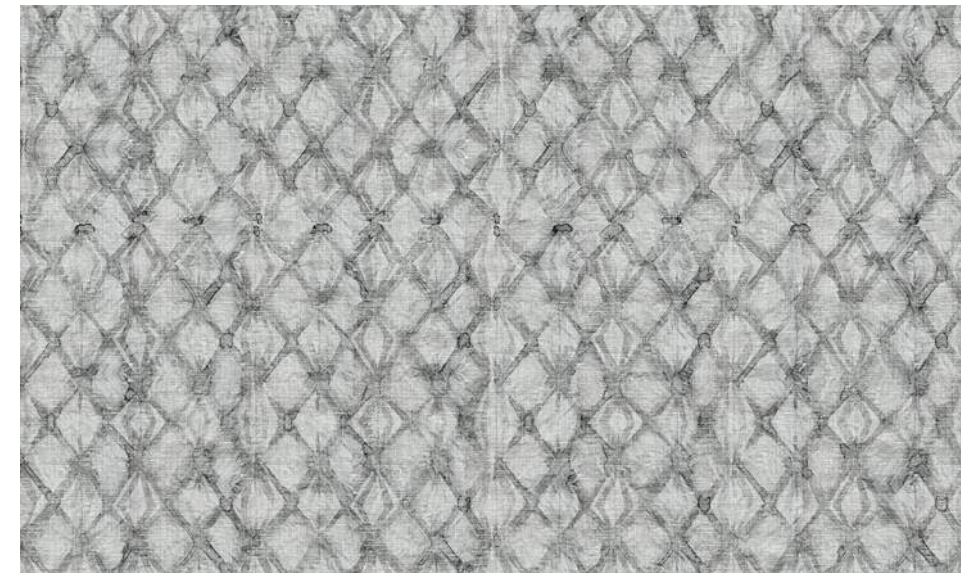

Codice/Code **WPT551**



Codice/Code **WPT550**

PAGE 126 - 179 - 271

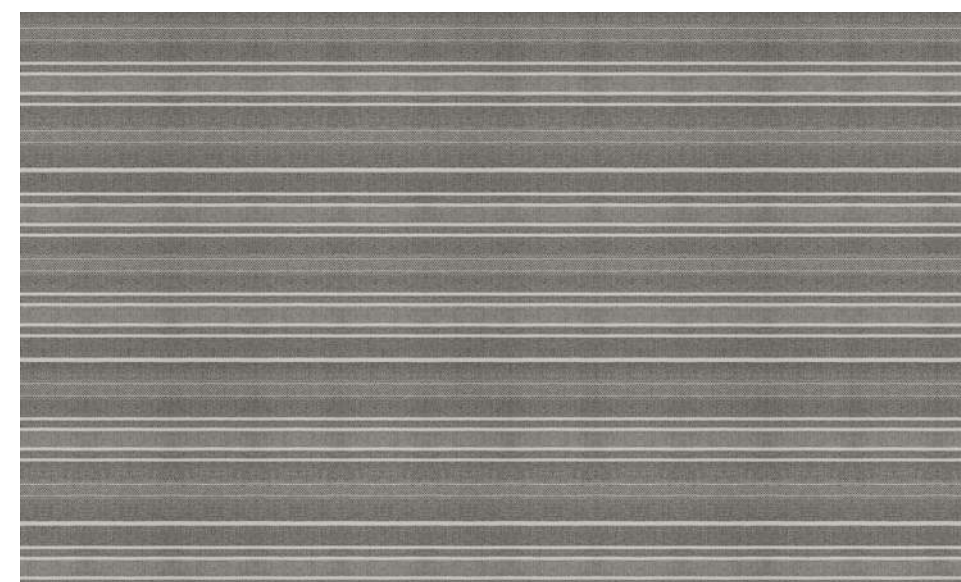

Codice/Code **WPT552**

PAGE 59 - 285



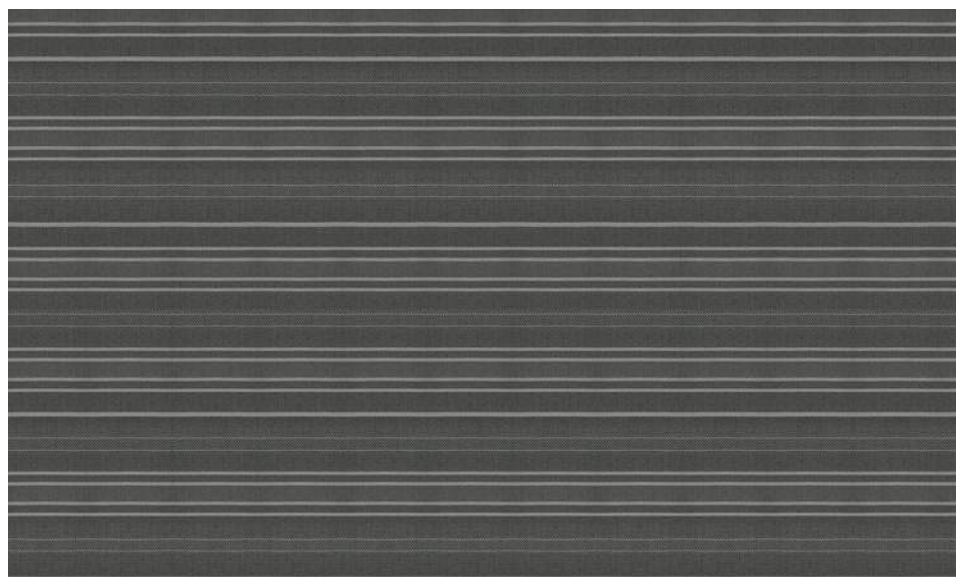

Codice/Code **WPT553**

PAGE 18 - 28 - 31 - 151



Codice/Code **WPT560**

PAGE 61 - 251

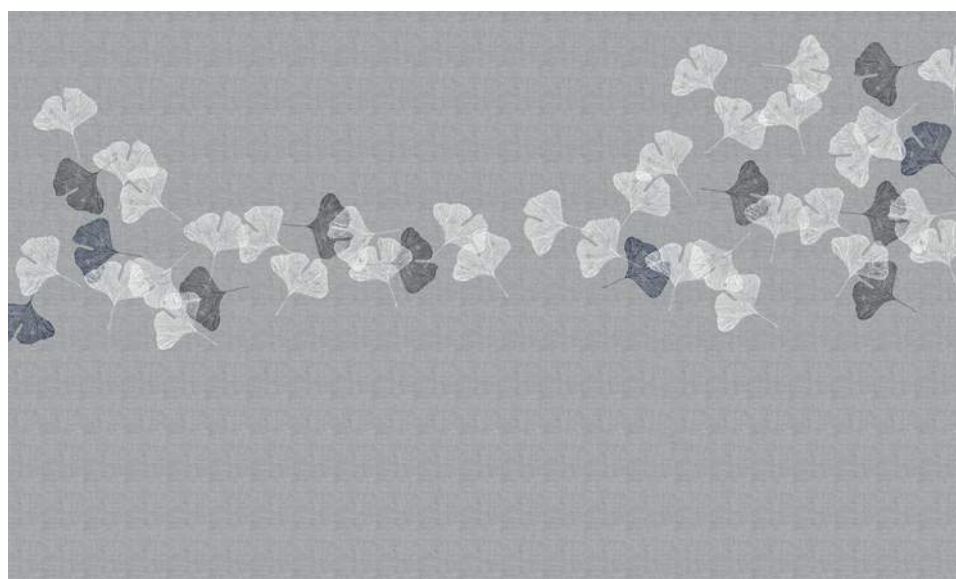

Codice/Code **WPT507**

PAGE 275

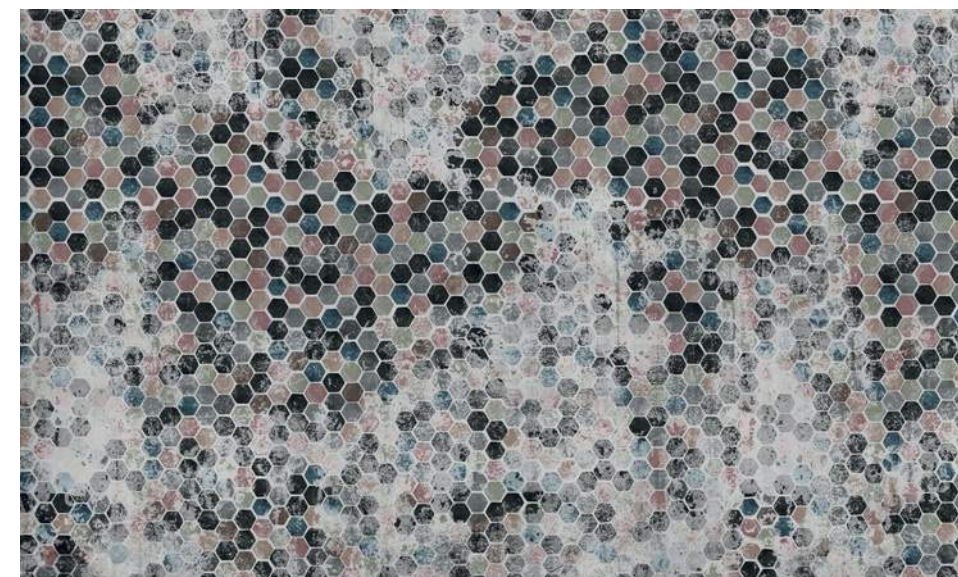

Codice/Code **WPT509**

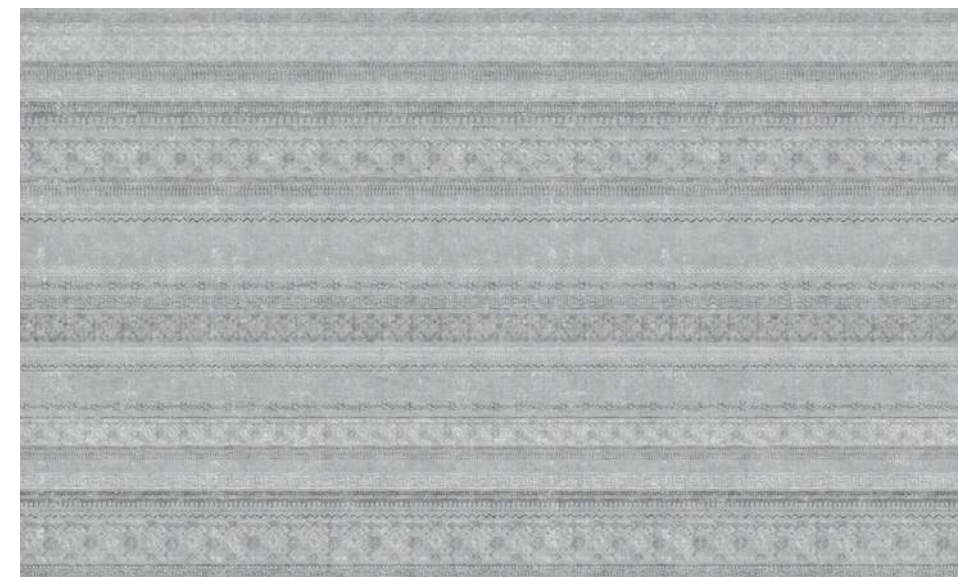

Codice/Code **WPT511**

PAGE 83 - 288



Codice/Code **WPT512**

PAGE 81 - 131 - 252



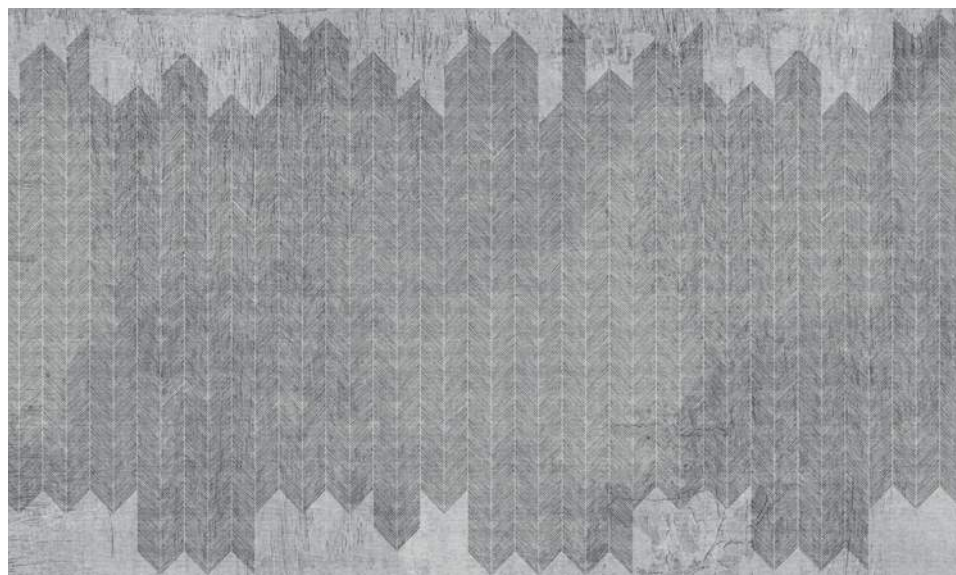

Codice/Code **WPT513**

PAGE 121 - 301 - 315



Codice/Code **WPT515**

PAGE 235

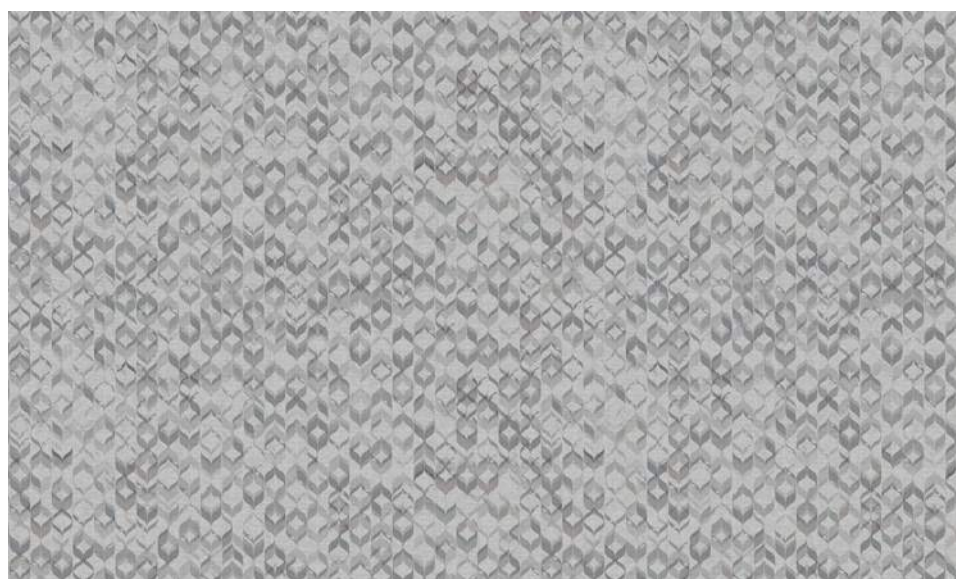

Codice/Code **WPT524**



Codice/Code **WPT517**



Codice/Code **WPT518**

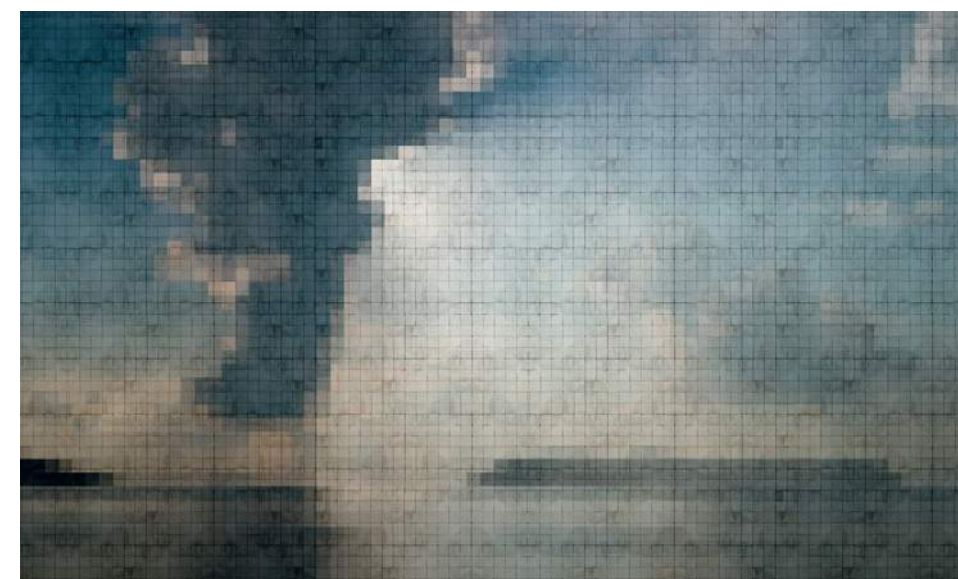

Codice/Code **WPT519**





Codice/Code **WPT520**



Codice/Code **WPT522**

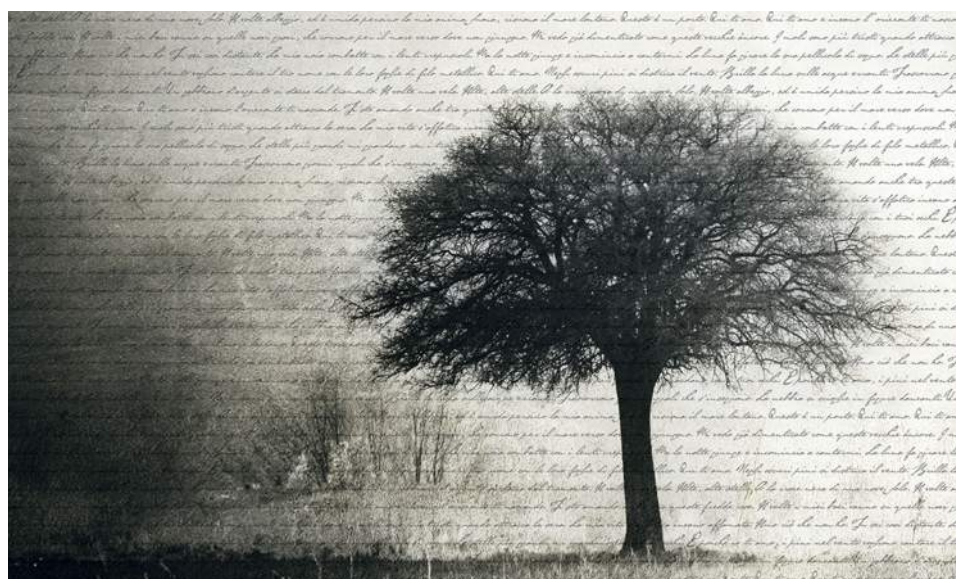

Codice/Code **WPT526**



Codice/Code **WPT527**

PAGE 79 - 184 - 277

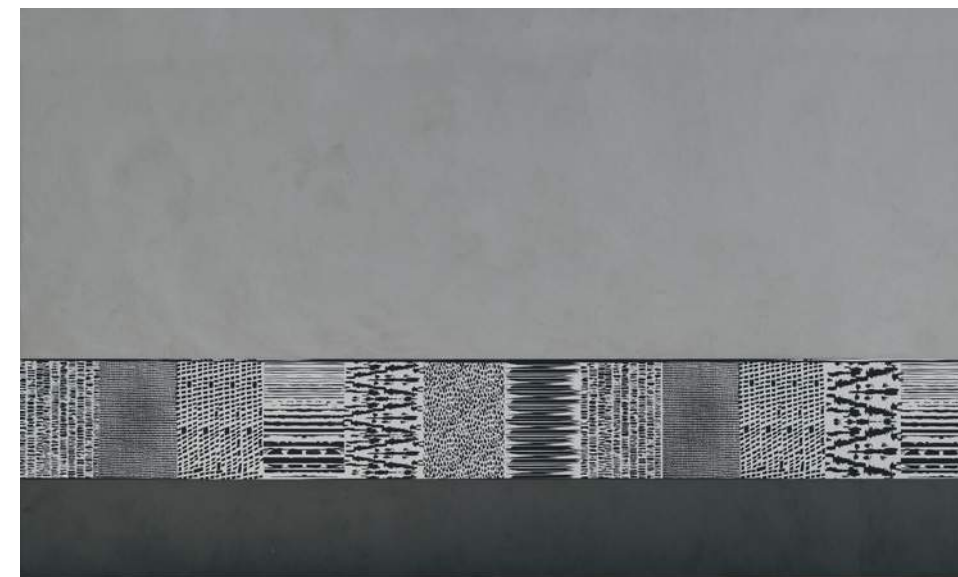

Codice/Code **WPT529**



Codice/Code **WPT530**



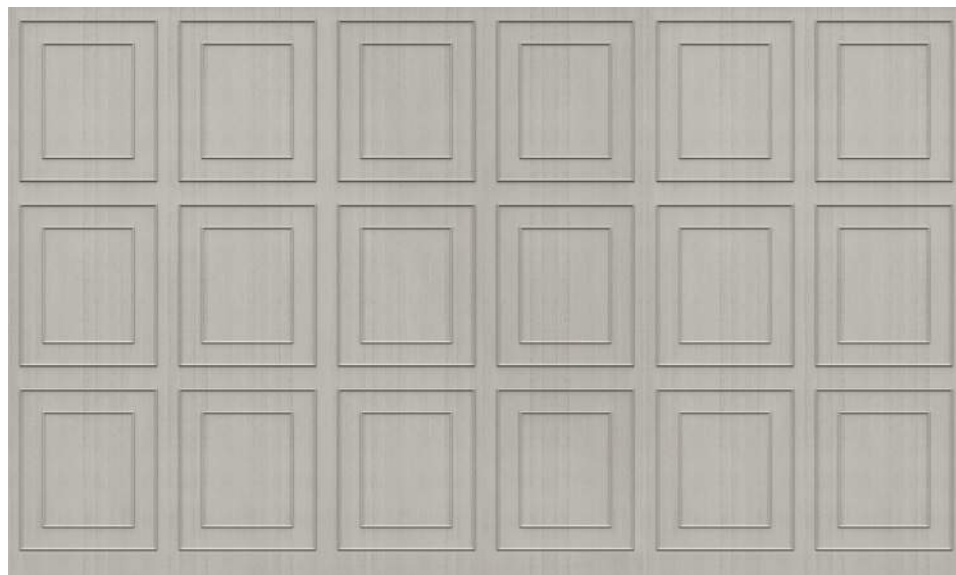

Codice/Code **WPT532**



Codice/Code **WPT533**

PAGE 68



Codice/Code **WPT534**

PAGE 226



Codice/Code **WPT535**

PAGE 73 - 78 - 175



Wallpaper per vani a giorno PETALO / Wallpaper for PETALO open units only

Codice/Code **WPT536**

PAGE 270



Wallpaper per vani a giorno PETALO / PETALO open units only

Codice/Code **WPT537**



Codice/Code **WPT538**



# Complementi technical pages

Decora la tua stanza con colore, materiali e grafiche: crea il tuo mood personale.  
Decorate your room with our colours,

materials and graphic designs:  
create your own, personal mood.

**Ante, ante kaos, schienali e pensile z** - Doors, kaos doors, back panels and z wall units

grafiche / graphic designs

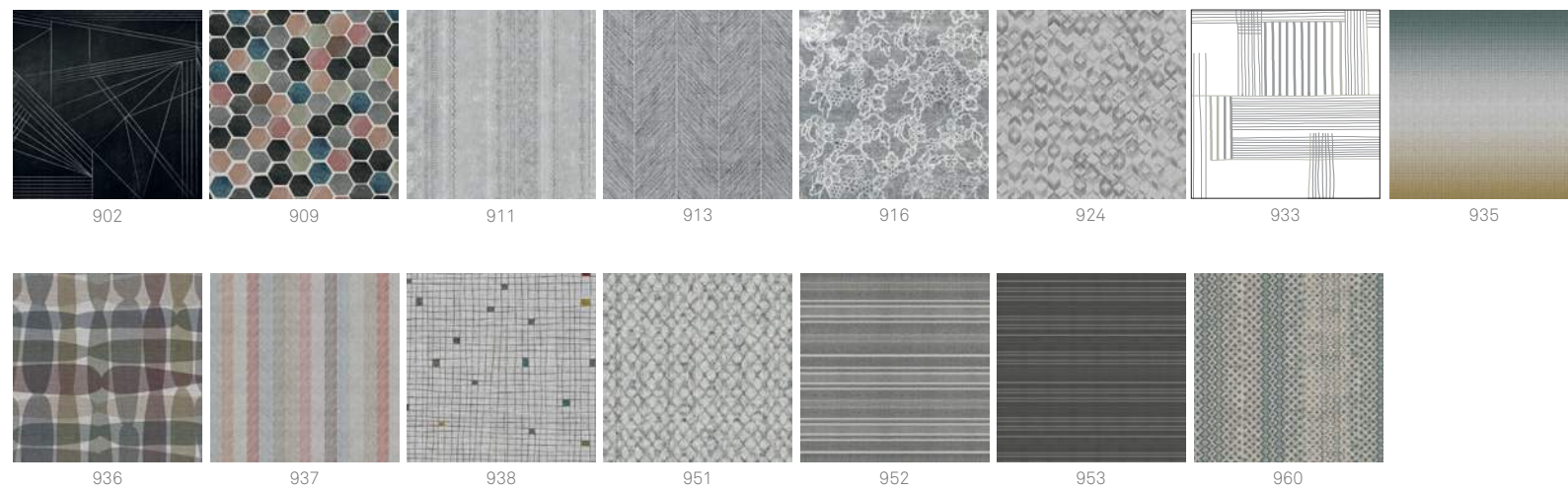

**Boiserie krea e pannello fortebraccio** - Krea back panels and fortebraccio panels



grafiche / graphic designs

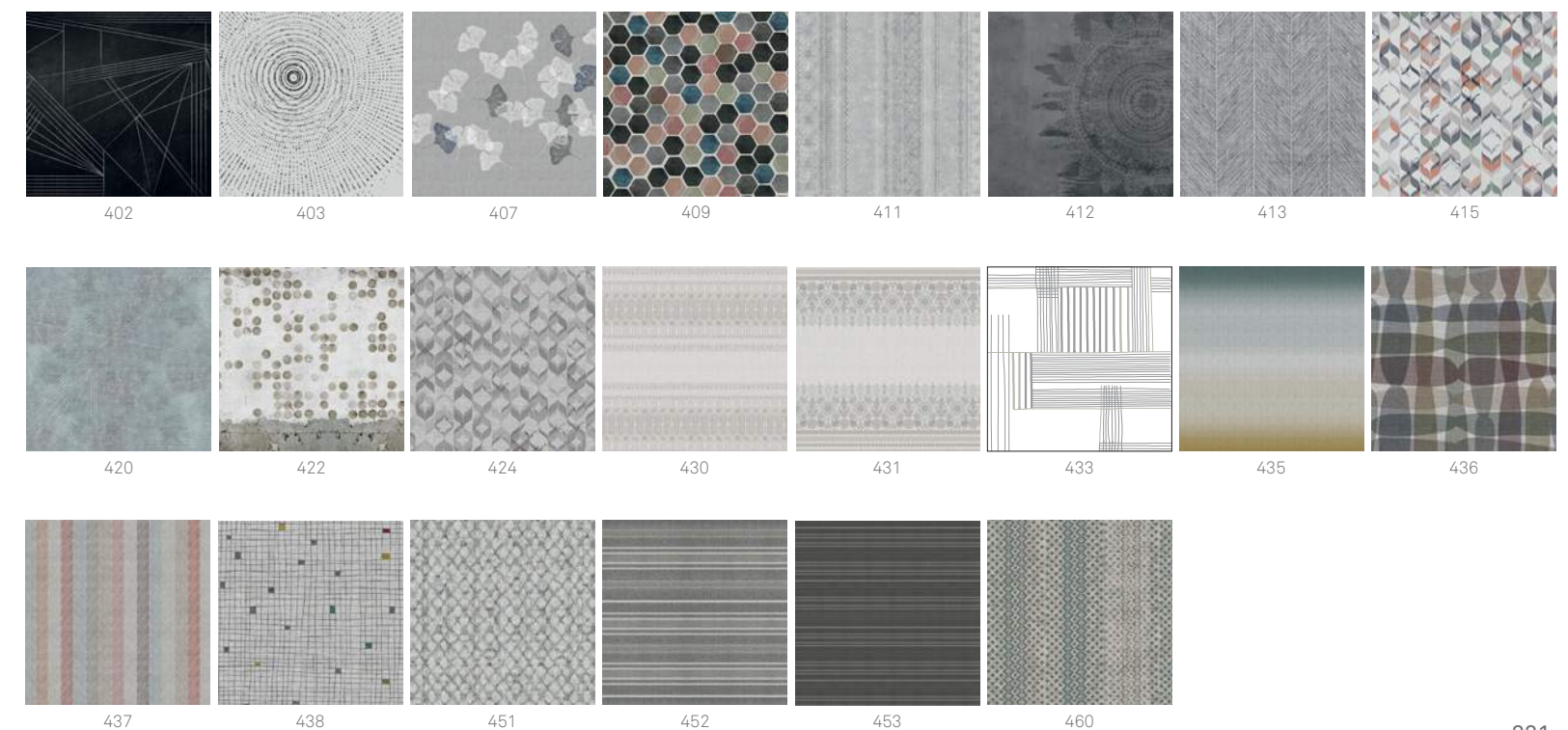



Essenze - Wood finishes

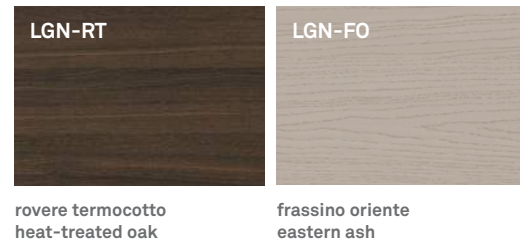

Tavolo Tudor - Tudor Table

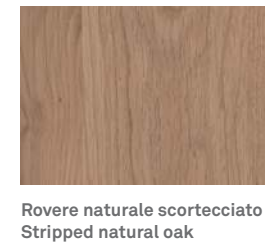

Materico essenza - Textured Wood



Materico - Textured



Materico opaco - Matt textured

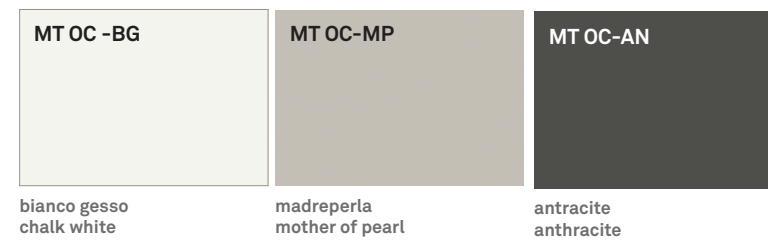

Materico poro aperto - Open pore textured



HPL

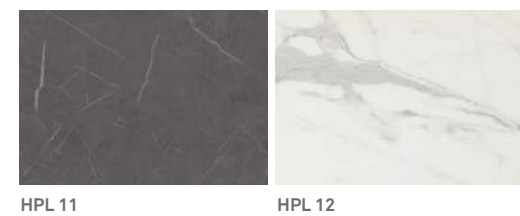

Laccati poro aperto - Open pore lacquers



Laccati opachi e lucidi - Matt and gloss lacquers





## Finiture telaio ante vetro - Glass door frame finishes



telaio titanio  
titanium frame



telaio colore\*  
coloured frame\*

\*In tutti i colori laccati della gamma Tomasella.  
\*In all the matt lacquer colours of the Tomasella range.

## Vetri e specchi per anta telaio - Glass and mirror options for framed doors

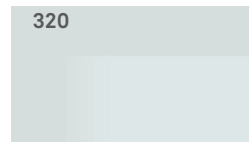

320  
vetro trasparente  
transparent glass

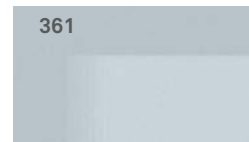

361  
vetro satinato  
satin glass

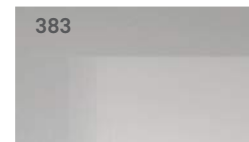

383  
specchio grigio  
grey mirror

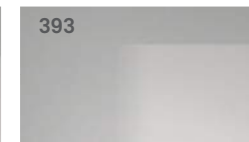

393  
specchio grigio satinato  
satin grey mirror

## Vetri laccati lucidi per anta telaio - Gloss glass options for framed doors

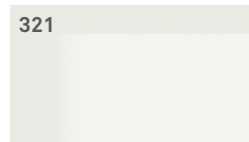

321  
bianco gesso  
chalk white

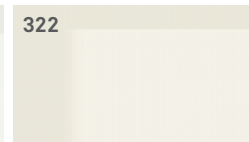

322  
panna  
cream

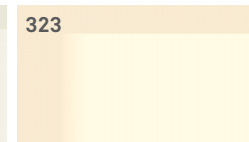

323  
avorio  
ivory

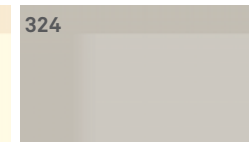

324  
madreperla  
mother of pearl

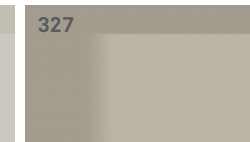

327  
hot  
hot grey

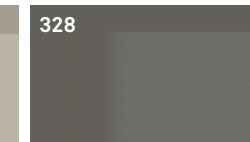

328  
smoke  
smoke



330  
grigio piacenza  
piacenza grey



331  
nero fumo  
smoke black



334  
rosso  
red

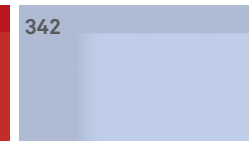

342  
celestè  
light blue



345  
pink  
pink



347  
oliva  
olive



348  
arancio  
orange



350  
canapa  
hemp

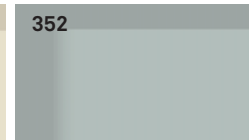

352  
pomice  
pumice

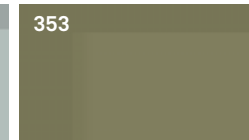

353  
verde muschio  
moss green

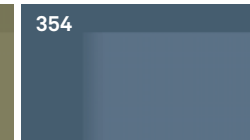

354  
blu avio  
air force blue

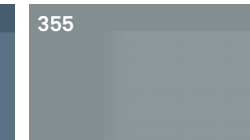

355  
carta da zucchero  
blue grey



356  
bordeaux  
burgundy



357  
pesca  
peach



358  
zafferano  
saffron

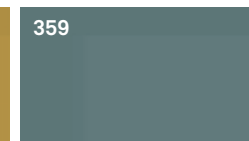

359  
salvia  
sage

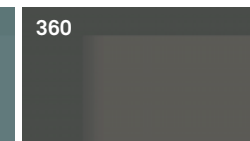

360  
antracite  
anthracite

## Finiture ante Metropolis - Metropolis door finishes



Elegante e lineare, l'anta Metropolis è disponibile con telaio in finitura antracite abbinata al vetro fumè o trasparente. Lo spessore verticale diventa presa maniglia per un'apertura pratica e bella. L'anta Metropolis è perfetta per composizioni spalla.

Elegant and linear, the Metropolis door is available with an anthracite finish frame paired with smoked or transparent glass. The vertical profile becomes a beautiful and practical grip edge. The Metropolis door pairs perfectly with open shelving units.

## Vetri per anta Metropolis - Metropolis door glass options

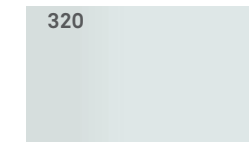

320  
vetro trasparente  
transparent glass

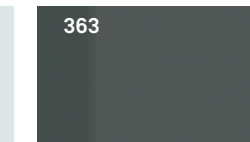

363  
vetro fumè  
smoked glass



# pagine di sintesi

testi in spagnolo,  
francese e tedesco

Páginas de síntesis

Descriptifs

Seitenübersicht

Textos en español, francés y alemán  
Textes en espagnol, français et allemand  
Texte in spanisch, französisch und deutsch





#### PAG 10

Mesa Plinto sobre cristal transparente 320, estructura madera roble termotratado y metal antracita 160.  
A 240 P 110 H 75 cm  
Sillas York estructura madera roble termotratado, revestimiento cat. b econobuk 12.  
A 47 P 61 H 92/48 cm  
Silla Lola estructura madera roble termotratado, revestimiento cat. c lino froissé 123.  
A 55 P 53 H 81/47 cm  
Aparador suspendido Sir S02 estructura lacado mate salvia 159 y madera roble termotratado.  
A 270 P 40 H 54 cm

Table Plinto plateau en verre transparent 320, structure en bois de chêne thermo-traité et métal anthracite 160.  
L 240 P 110 H 75 cm  
Chaises York structure en bois de chêne thermo-traité, revêtement cat.b éconobuk 12.  
L 47 P 61 H 92/48 cm  
Chaise Lola structure en bois de chêne thermo-traité, revêtement cat.c lin froissé 123.  
L 55 P 53 H 81/47 cm  
Buffet suspendu Sir S02 structure laquée sauge 159 mat et bois de chêne thermo-traité.  
L 270 P 40 H 54 cm

Tisch Plinto Platte aus transparentem Glas 320, Struktur Holz Thermoeiche und Metall Anthrazit 160.  
B. 240 T. 110 H. 75 cm  
Stuhl York Struktur Holz Thermoeiche, Bezug Kat. B Econabuk 12.  
B. 47 T. 61 H. 92/48 cm  
Stuhl Lola Struktur Holz Thermoeiche, Bezug Kat. C Leinen Froissé 123.  
B. 55 T. 53 H. 81/47 cm  
Wandhängendes Sideboard Sir S02 Struktur matt lackiert Salbei 159, Holz Thermoeiche.  
B. 270 T. 40 H. 54 cm



#### PAG 14

Mesa Avalon sobre Hpl 12, estructura madera lacada poro abierto antracita 260.  
A 240 P 120 H 75 cm  
Sillas Betty cat. b ecopiel extrema 16. A 45 P 54 H 81/46 cm  
Aparadores Regolo R03 estructura texturizado mate blanco yeso, aplicación tirador texturizado mate antracita y metal antracita 160.  
A 108 P 40 H 147,5 cm  
Alfombra Gradient.

Table Avalon plateau Hpl 12, structure en bois laqué anthracite 260 à pores ouverts.  
L 240 P 120 H 75 cm  
Chaises Betty cat.b écocuir extrema 16.  
L 45 P 54 H 81/46 cm

Buffets Regolo R03 structure en texturé blanc craie mat, insert poignée en texturé anthracite mat et en métal anthracite 160.  
L 108 P 40 H 147,5 cm  
Tapis Gradient.

Tisch Avalon Platte HPL 12, Struktur Holz offenporig lackiert Anthrazit 260.  
B. 240 T. 120 H. 75 cm  
Stuhl Betty Kat. B Lederimitat Extrema 16.  
B. 45 T. 54 H. 81/46 cm  
Sideboard Regolo R03 Struktur Rau matt Gipsweiß, Griffesatz Rau matt Anthrazit und Metall Anthrazit 160.  
B. 108 T. 40 H. 147,5 cm  
Teppich Gradient.



#### PAG 18

Mesa Avalon sobre Hpl 11, estructura madera lacada poro abierto antracita 260.  
A 240 P 120 H 75 cm  
Sillas Bea estructura madera roble termotratado.  
A 42 P 53 H 78/44 cm  
Contenedores suspendidos Atlante lacado mate antracita 160.  
A 288 P 40 H 37,4 cm  
Alfombra Black & White.  
Wallpaper WPT 553.

Table Avalon plateau Hpl 11, structure en bois laqué anthracite 260 à pores ouverts.  
L 240 P 120 H 75 cm  
Chaises Bea structure en bois de chêne thermo-traité.  
L 42 P 53 H 78/44 cm  
Éléments suspendus Atlante laqués anthracite 160 mat.  
L 288 P 40 H 37,4 cm  
Tapis Black & White.  
Papier peint WPT 553.

Tisch Avalon Platte HPL 11, Struktur Holz offenporig lackiert Anthrazit 260.  
B. 240 T. 120 H. 75 cm  
Stuhl Bea Struktur Holz Thermoeiche.  
B. 42 T. 53 H. 78/44 cm  
Wandhängende Möbelemente Atlante matt lackiert Anthrazit 160.  
B. 288 T. 40 H. 37,4 cm  
Teppich Black & White.  
Wallpaper WPT 553.



#### PAG 20

Mesa Avalon sobre texturizado cemento claro, estructura madera lacada poro abierto antracita 260.  
A 240 P 120 H 76,8 cm

Sillas York estructura madera lacada poro abierto antracita 260, revestimiento cat. b ecopiel vintage 101.  
A 47 P 61 H 92/48 cm

Table Avalon plateau en texturé ciment clair, structure en bois laqué anthracite 260 à pores ouverts.  
L 240 P 120 H 76,8 cm  
Chaises York structure en bois laqué anthracite 260 à pores ouverts, revêtement cat.b écocuir vintage 101.  
L 47 P 61 H 92/48 cm

Tisch Avalon Platte HPL 12, Struktur Holz offenporig lackiert Anthrazit 260.  
B. 240 T. 120 H. 76,8 cm  
Stuhl York Struktur Holz offenporig lackiert Anthrazit 260, Bezug Kat. B Lederimitat Vintage 101.  
B. 47 T. 61 H. 92/48 cm



#### PAG 24

Mesa Tudor sobre roble natural descortezado, estructura metal antracita 160 y metal blanco yeso 121.  
A 350 P 110 H 74 cm  
Sillas Betty cat. b ecopiel vintage 1009.  
A 45 P 54 H 81/46 cm  
Alfombra Dots.

Table Tudor plateau en chêne naturel raboté, structure en métal anthracite 160 et métal blanc craie 121.  
L 350 P 110 H 74 cm  
Chaises Betty cat.b écocuir vintage 1009.  
L 45 P 54 H 81/46 cm  
Tapis Dots.

Tisch Tudor Platte Eiche Natur geschält, Struktur Metall Anthrazit 160 und Metall Gipsweiß 121.  
B. 350 T. 110 H. 74 cm  
Stuhl Betty Kat. B Lederimitat Vinage 1009.  
B. 45 T. 54 H. 81/46 cm  
Teppich Dots.



#### PAG 28

Mesa Tudor sobre madera roble natural descortezado, estructura metal antracita 160 y metal burdeos 156.  
A 350 P 110 H 74 cm  
Sillas Tiffany Faldón cat. c lino froissé 019.  
A 46 P 50 H 83/47 cm  
Wallpaper WPT 553.

Table Tudor plateau en bois de chêne naturel raboté, structure en métal anthracite 160 et métal bordeaux 156.  
L 350 P 110 H 74 cm  
Chaises Tiffany Gonna cat.c lin froissé 019.  
L 46 P 50 H 83/47 cm

Papier peint WPT 553.

Tisch Tudor Platte Holz Eiche Natur geschält, Struktur Metall Anthrazit 160 und Metall Bordeaux 156.  
B. 350 T. 110 H. 74 cm  
Stuhl Tiffany mit Husse Kat. C Leinen Froissé 019.  
B. 46 T. 50 H. 83/47 cm  
Wallpaper WPT 553.



#### PAG 32

Mesa Brigitte sobre texturizado con nudos oscuro, estructura metal antracita 160.  
Ø 120 H 75 cm.  
Silla Betty cat. 1/one atom 10.  
A 45 P 54 H 81/46 cm.  
Librería Movida estructura metal antracita 160, estantes texturizado con nudos oscuro.  
A 74 P 38 H 190 cm.

Table Brigitte plateau en texturé chêne à nœuds foncé, structure en métal anthracite 160.  
Ø 120 H 75 cm  
Chaise Betty cat. 1/one atom 10.  
L 45 P 54 H 81/46 cm  
Bibliothèque Movida structure en métal anthracite 160, tablettes en texturé chêne à nœuds foncé.  
L 74 P 38 H 190 cm

Tisch Brigitte Platte Rau astig dunkel, Struktur Metall Anthrazit 160.  
Ø 120 H. 75 cm  
Stuhl Betty Kat. 1/One Atom 10.  
B. 45 T. 54 H. 81/46 cm  
Bücherregal Movida Struktur Metall Anthrazit 160, Fachböden Rau astig dunkel.  
B. 74 T. 38 H. 190 cm



#### PAG 34

Mesa Brigitte sobre lacado mate azafrán 158, estructura metal azafrán 158.  
Ø 120 H 75 cm  
Silla Tiffany Faldón cat. c lino froissé 019.  
A 46 P 50 H 83/47 cm  
Aparador Madison lacado mate antracita 160.  
A 207 P 49 H 76 cm  
Mesita 3 versión 12.  
Ø 40 H 38 cm

Table Brigitte plateau laqué safran 158 mat, structure en métal safran 158.  
Ø 120 H 75 cm  
Chaise Tiffany Gonna cat.c lin froissé 019.  
L 46 P 50 H 83/47 cm  
Buffet Madison laqué anthracite 160 mat.

L 207 P 49 H 76 cm  
Table basse 33 version 12.  
Ø 40 H 38 cm

Tisch Brigitte Platte matt lackiert Safrangelb 158, Struktur Metall Safrangelb 158.  
Ø 120 H. 75 cm  
Stuhl Tiffany mit Husse Kat. C Leinen Froissé 019.  
B. 46 T. 50 H. 83/47 cm  
Sideboard Madison matt lackiert Anthrazit 160.  
B. 207 T. 49 H. 76 cm  
Beistelltisch 33 Version 12.  
Ø 40 H. 38 cm



#### PAG 37

Mesa Brigitte sobre decoración 350, estructura metal antracita 160.  
Ø 120 H 75 cm  
Sillas Tiffany Faldón cat. c lino froissé 100.  
A 46 P 50 H 83/47 cm  
Alfombra Black & White.

Table Brigitte plateau avec décor graphique 350, structure en métal anthracite 160.  
Ø 120 H. 75 cm  
Chaises Tiffany Gonna cat.c lin froissé 100.  
L 46 P 50 H 83/47 cm  
Tapis Black & White.

Tisch Brigitte Platte mit Grafikmuster 350, Struktur Metall Anthrazit 160.  
Ø 120 H. 75 cm  
Stuhl Tiffany mit Husse Kat. C Leinen Froissé 100.  
B. 46 T. 50 H. 83/47 cm  
Teppich Black & White.



#### PAG 40

Mesa Bloom estructura madera roble termotratado, aplicación cobre.  
A 220 P 110 H 75 cm  
Sillas York estructura madera roble termotratado, revestimiento cat. b ecopiel vintage 107.  
A 47 P 61 H 92/48 cm  
Aparador Athena 3 puertas estructura lacado mate pómez 152, aplicación cristal antracita 360.  
A 181 P 51 H 85 cm

Table Bloom structure en bois de chêne thermo-traité, filet cuivre.  
L 220 P 110 H 75 cm  
Chaises York structure en bois de chêne thermo-traité, revêtement cat.b écocuir vintage 107.  
L 47 P 61 H 92/48 cm  
Buffet Athena 3 portes, structure laquée ponce 152 mat, bandeau en verre anthracite 360.  
L 181 P 51 H 85 cm

Tisch Bloom Struktur Holz Thermoeiche, Einsatz Kupfer.  
B. 220 T. 110 H. 75 cm  
Stuhl York Struktur Holz Thermoeiche, Bezug Kat. B Lederimitat Vintage 107.  
B. 47 T. 61 H. 92/48 cm  
Sideboard Athena 3 Türen Struktur matt lackiert Bimsstein 152, Einsatz Glas Anthrazit 360.  
B. 181 T. 51 H. 85 cm



#### PAG 43

Mesa Bloom estructura madera roble termotratado, aplicación cobre.  
A 150 P 150 H 75 cm  
Sillas York estructura madera roble termotratado, revestimiento cat. b ecopiel vintage 1011.  
A 47 P 61 H 92/48 cm  
Alfombra Gradient.

Table Bloom structure en bois de chêne thermo-traité, filet cuivre.  
L 150 P 150 H 75 cm  
Chaises York structure en bois de chêne thermo-traité, revêtement cat.b écocuir vintage 1011.  
L 47 P 61 H 92/48 cm  
Tapis Gradient.

Tisch Bloom Struktur Holz Thermoeiche, Einsatz Kupfer.  
B. 150 T. 150 H. 75 cm  
Stuhl York Struktur Holz Thermoeiche, Bezug Kat. B Lederimitat Vintage 1011.  
B. 47 T. 61 H. 92/48 cm  
Teppich Gradient.



#### PAG 44

Mesa Bloom sobre gres 02, estructura madera roble termotratado.  
A 220 P 110 H 75 cm  
Silla Lolita estructura madera roble termotratado, revestimiento cat. b hugo 04.



A 51 P 56 H 79/47 cm  
Silla Lolita estructura madera roble termotrataado, revestimiento cat. b ecopiel vintage 102.  
A 51 P 56 H 79/47 cm  
Silla Lola estructura madera roble termotrataado, revestimiento cat. b ecopiel extrema 12.  
A 55 P 53 H 81/47 cm  
Alfombra Frame.

Table Bloom plateau en grès 02, structure en bois de chêne thermo-traité.  
L 220 P 110 H 75 cm  
Chaise Lolita structure en bois de chêne thermo-traité, revêtement cat.b hugo 04.  
L 51 P 56 H 79/47 cm  
Chaise Lolita structure en bois de chêne thermo-traité, revêtement cat.b écocuir vintage 102.  
L 51 P 56 H 79/47 cm  
Chaise Lolita structure en bois de chêne thermo-traité, revêtement cat.b écocuir extrema 12.  
L 55 P 53 H 81/47 cm  
Tapis Frame.

Tisch Bloom Platte Gres 02, Struktur Holz Thermoeiche.  
B. 220 T. 110 H. 75 cm  
Stuhl Lolita Struktur Holz Thermoeiche, Bezug Kat. B Hugo 04.  
B. 51 T. 56 H. 79/47 cm  
Stuhl Lolita Struktur Holz Thermoeiche, Bezug Kat. B Lederimitat Vintage 102.  
B. 51 T. 56 H. 79/47 cm  
Stuhl Lola Struktur Holz Thermoeiche, Bezug Kat. B Lederimitat Extrema 12.  
B. 55 T. 53 H. 81/47 cm  
Teppich Frame.



#### PAG 48

Mesa extensible Doppio Passo estructura texturizado fresno oriente.  
A 160 (205/250) P 90 H 75 cm  
Silla Skinny cat. b ecopiel vintage 102.  
A 46 P 56 H 95/48 cm  
Aparador Diagonal Var. A texturizado fresno oriente y metal blanco yeso 121.  
A 219 P 51 H 85 cm  
Estantes Ring texturizado fresno oriente y metal blanco yeso 121. A 144 P 26 H 27 cm  
Reloj 670.  
Alfombra Diagonal.

Table à rallonges Doppio Passo structure en texturé frêne orient.  
L 160 (205/250) P 90 H 75 cm  
Chaise Skinny cat. B écocuir vintage 102.  
L 46 P 56 H 95/48 cm  
Buffet Diagonal Var. A en texturé frêne orient et métal blanc craie 121.  
L 219 P 51 H 85 cm  
Étagères Ring en texturé frêne orient et métal blanc craie 121.  
L 144 P 26 H 27 cm  
Horloge 670.  
Tapis Diagonal.

Ausziehtisch Doppio Passo Struktur Rau Esche Oriente.  
B. 160 (205/250) T. 90 H. 75 cm  
Stuhl Skinny Kat. B Lederimitat Vintage 102.  
B. 46 T. 56 H. 95/48 cm  
Sideboard Diagonal Var. A Rau Esche Oriente und Metall Gipsweiß 121.  
B. 219 T. 51 H. 85 cm  
Borde Ring Rau Esche Oriente und Metall Gipsweiß 121.  
B. 144 T. 26 H. 27 cm  
Uhr 670.  
Teppich Diagonal.



#### PAG 52

Mesa Doppio Passo estructura madera lacada poro abierto hot 227.  
A 170 (215/260) P 100 H 75 cm  
Sillas Skinny cat. 1/one atom 34.  
A 46 P 56 H 95/48 cm  
Aparador Atlante lacado mate hot 127 y espejo gris 383.  
A 192 P 54 H 76 cm  
Puf Guccino cat. b ecopiel vintage 107 y lacado mate hot 127.  
Ø 40 H 53 cm  
Alfombra Frame.

Table Doppio Passo structure en bois laqué hot 227 à pores ouverts.  
L 170 (215/260) P 100 H 75 cm  
Chaises Skinny cat 1/one atom 34.  
L 46 P 56 H 95/48 cm  
Buffet Atlante laqué hot 127 mat et miroir gris 383.  
L 192 P 54 H 76 cm  
Pouf Guccino cat.b écocuir vintage 107 et laqué hot 127 mat.  
Ø 40 H 53 cm  
Tapis Frame.

Tisch Doppio Passo Struktur Holz offenporig lackiert Hot 227.  
B. 170 (215/260) T. 100 H. 75 cm  
Stühle Skinny Kat 1/One Atom 34.  
B. 46 T. 56 H. 95/48 cm  
Sideboard Atlante matt lackiert Hot 127 und Spiegel Grau 383.  
B. 192 T. 54 H. 76 cm  
Hocker Guccino Kat. B Lederimitat Vintage 107 und matt lackiert Hot 127.  
Ø 40 H. 53 cm  
Teppich Frame.



#### PAG 55

Mesa Doppio Passo estructura madera roble termotrataado.  
A 170 (215/260) P 100 H 75 cm  
Silla Lola estructura madera roble termotrataado/cat. b ecopiel extrema 12.  
A 55 P 53 H 81/47 cm  
Silla Lolita estructura madera roble termotrataado/cat. b hugo 04.  
A 51 P 56 H 79/47 cm

Table Doppio Passo structure en bois de chêne thermo-traité.  
L 170 (215/260) P 100 H 75 cm  
Chaise Lola structure en bois de chêne thermo-traité/cat.b

écocuir extrema 12.  
L 55 P 53 H 81/47 cm  
Chaise Lolita structure en bois de chêne thermo-traité/cat.b hugo 04.  
L 51 P 56 H 79/47 cm

Tisch Doppio Passo Struktur Holz Thermoeiche.  
B. 170/215-260 T. 100 H. 75 cm  
Stuhl Lola Struktur Holz Thermoeiche/Kat. B Lederimitat Extrema 12.  
B. 55 T. 53 H. 81/47 cm  
Stuhl Lolita Struktur Holz Thermoeiche/Kat. B Hugo 04.  
B. 51 T. 56 H. 79/47 cm



#### PAG 56

Mesa Infinity extensible sobre texturizado cemento oscuro, estructura peltre.  
A 280/330-380 P 110 H 75 cm  
Silla Tiffany Faldón cat. b linara 08 y cat. c lino froissé 100.  
A 46 P 50 H 83/47 cm  
Puf Cookie cat. c lino froissé 100 / hilo 0856.  
A 47 P 47 H 46 cm  
Librería Movida estructura metal antracita 160, estantes texturizado con nudos claro.  
A 74 P 38 H 190 cm

Table à rallonges Infinity plateau en texturé ciment foncé, structure finition étain.  
L 280/330-380 P 110 H 75 cm  
Chaise Tiffany Gonna cat.b linara 08 et cat.c lin froissé 100.  
L 46 P 50 H 83/47 cm  
Pouf Cookie cat.c lin froissé 100 / fil 0856.  
L 47 P 47 H 46 cm  
Bibliothèque Movida structure en métal anthracite 160, tablettes en texturé chêne à nœuds clair.  
L 74 P 38 H 190 cm

Ausziehtisch Infinity Platte Rau Zement dunkel, Struktur Zinn.  
B. 280/330-380 T. 110 H. 75 cm  
Stuhl Tiffany mit Husse Kat. B Linara 08 und Kat. C Leinen Froissé 100.  
B. 46 T. 50 H. 83/47 cm  
Hocker Cookie Kat. C Leinen Froissé 100 / Ziernaht 0856.  
B. 47 T. 47 H. 46 cm  
Bücherregal Movida Struktur Metall Anthrazit 160, Fachböden Rau astig hell.  
B. 74 T. 38 H. 190 cm



#### PAG 59

Mesa Infinity fija sobre texturizado maya bronze, estructura

peltre.  
A 140 P 140 H 75 cm  
Silla York estructura madera roble termotrataado, revestimiento cat. b ecopiel vintage 106.  
A 47 P 61 H 92/48 cm  
Librería Movida estructura metal antracita 160, estantes texturizado Maya bronze.  
A 74 P 38 H 190 cm.  
Wallpaper WPT552.

Table fixe Infinity plateau en texturé maya bronze, structure finition étain.  
L 140 P 140 H 75 cm  
Chaise York structure en bois de chêne thermo-traité, revêtement cat. B écocuir vintage 106.  
L 47 P 61 H 92/48 cm  
Bibliothèque Movida structure en métal anthracite 160, tablettes en texturé maya bronze.  
L 74 P 38 H 190 cm  
Papier peint WPT552.

Fixer Tisch Infinity Platte Rau Maya Bronze, Struktur Zinn.  
B. 140 T. 140 H. 75 cm  
Stuhl York Struktur Holz Thermoeiche, Bezug Kat. B Lederimitat Vintage 106.  
B. 47 T. 61 H. 92/48 cm  
Bücherregal Movida Struktur Metall Anthrazit 160, Fachböden Maya Bronze.  
B. 74 T. 38 H. 190 cm  
Wallpaper WPT552.



#### PAG 61

Mesa Infinity sobre texturizado con nudos claro, estructura metal blanco yeso 121.  
A 160/200-240 P 90 H 75 cm  
Silla Tiffany Faldón cat. c lino froissé 011, 123, 010, 019.  
A 46 P 50 H 83/47 cm  
Wallpaper WPT 560.

Table Infinity plateau en texturé chêne à nœuds clair, structure en métal blanc craie 121.  
L 160/200-240 P 90 H 75 cm  
Chaise Tiffany Gonna cat. C lin froissé 011, 123, 010, 019.  
L 46 P 50 H 83/47 cm  
Papier peint WPT 560.

Tisch Infinity Platte Rau astig hell, Struktur Metall Gipsweiß 121.  
B. 160/200-240 T. 90 H. 75 cm  
Stuhl Tiffany mit Husse Kat. C Leinen Froissé 011, 123, 010, 019.  
B. 46 T. 50 H. 83/47 cm  
Wallpaper WPT 560.



#### PAG 67

Silla York estructura madera roble termotrataado, revestimiento cat. b ecopiel vintage 106.  
A 47 P 61 H 92/48 cm

Chaise York structure en bois de chêne thermo-traité, revêtement cat.b écocuir vintage 106.  
L 47 P 61 H 92/48 cm

Stuhl York Struktur Holz Thermoeiche, Bezug Kat. B Lederimitat Vintage 106.  
B. 47 T. 61 H. 92/48 cm



#### PAG 68

Silla Lolita  
01. estructura madera fresno oriente, revestimiento cat. b ecopiel extrema 34.  
02. estructura madera lacada poro abierto madreperla 224, revestimiento cat. c lino froissé 20.  
03. estructura madera lacada poro abierto pómez 252, revestimiento cat. d nubes 09.  
04. estructura madera lacada poro abierto antracita 260, revestimiento cat. d nubes 09.  
A 51 P 56 H 79/47 cm  
Wallpaper WPT 533.

Chaise Lolita  
01. structure en bois de frêne orient, revêtement cat.b écocuir extrema 34.  
02. structure en bois laqué nacre 224 à pores ouverts, revêtement cat.c lin froissé 20.  
03. structure en bois laqué ponce 252 à pores ouverts, revêtement cat.d nubes 09.  
04. structure en bois laqué anthracite 260 à pores ouverts, revêtement cat.d nubes 09.  
L 51 P 56 H 79/47 cm  
Papier peint WPT 533.

Stuhl Lolita  
01. Struktur Holz Esche Oriente, Bezug Kat. B Lederimitat Extrema 34.  
02. Struktur Holz offenporig lackiert Perlmutter 224, Bezug Kat. C Leinen Froissé 20.  
03. Struktur Holz offenporig lackiert Bimsstein 252, Bezug Kat. D Nubes 09.  
04. Struktur Holz offenporig lackiert Anthrazit 260, Bezug Kat. D Nubes 09.  
B. 51 T. 56 H. 79/47 cm  
Wallpaper WPT 533.



#### PAG 71

Silla Lolita  
01. estructura madera roble termotrataado, revestimiento cat. b hugo 04.  
02. estructura madera roble termotrataado, revestimiento cat. b ecopiel vintage 102.  
03. estructura madera roble termotrataado, revestimiento cat. b ecopiel vintage 107.  
A 51 P 56 H 79/47 cm

Chaise Lolita  
01. structure en bois de chêne thermo-traité, revêtement cat.b hugo 04.  
02. structure en bois de chêne thermo-traité, revêtement cat.b écocuir vintage 102.  
03. structure en bois de chêne thermo-traité, revêtement cat.b écocuir vintage 107.  
L 51 P 56 H 79/47 cm

Stuhl Lolita  
01. Struktur Holz Thermoeiche, Bezug Kat. B Hugo 04.  
02. Struktur Holz Thermoeiche, Bezug Kat. B Lederimitat Vintage 102.  
03. Struktur Holz Thermoeiche, Bezug Kat. B Lederimitat Vintage 107.  
B. 51 T. 56 H. 79/47 cm



#### PAG 72

Silla Lola estructura madera roble termotrataado, revestimiento cat. d nubes 10.  
A 55 P 53 H 81/47 cm

Chaise Lola structure en bois de chêne thermo-traité, revêtement cat.d nubes 10.  
L 55 P 53 H 81/47 cm

Stuhl Lola Struktur Holz Thermoeiche, Bezug Kat. D Nubes 10.  
B. 55 T. 53 H. 81/47 cm





#### PAG 73

**Silla Lola**  
 01. estructura madera roble termotrataado, revestimiento cat. d nubes 07.  
 02. estructura madera roble termotrataado, revestimiento cat. d nubes 09.  
 03. estructura madera roble termotrataado, revestimiento cat. c lino froissè 100.  
 A 55 P 53 H 81/47 cm  
 Wallpaper WPT535.

**Chaise Lola**  
 01. structure en bois de chêne thermo-traité, revêtement cat. d nubes 07.  
 02. structure en bois de chêne thermo-traité, revêtement cat. d nubes 09.  
 03. structure en bois de chêne thermo-traité, revêtement cat. c lin froissè 100.  
 L 55 P 53 H 81/47 cm  
 Papier peint WPT 535.

**Stuhl Lola**  
 01. Struktur Holz Thermoeiche, Bezug Kat. D Nubes 07.  
 02. Struktur Holz Thermoeiche, Bezug Kat. D Nubes 09.  
 03. Struktur Holz Thermoeiche, Bezug Kat. C Leinen Froissè 100.  
 B. 55 T. 53 H. 81/47 cm  
 Wallpaper WPT535.



#### PAG 75

**Sillas Bea estructura madera roble termotrataado.**  
 A 42 P 53 H 78/44 cm

**Chaises Bea structure en bois de chêne thermo-traité.**  
 L 42 P 53 H 78/44 cm

**Stuhl Bea Struktur Holz Thermoeiche.**  
 B. 42 T. 53 H. 78/44 cm



#### PAG 77

**01. Sillas Time estructura madera roble termotrataado, revestimiento cat. b ecopiel vintage 107.**  
**02. Silla Time estructura madera fresno oriente, revestimiento cat. b ecopiel vintage 107.**  
 A 43 P 52 H 80/44 cm

**01. Chaises Time structure en bois de chêne thermo-traité, revêtement cat. b écocuir vintage 107.**  
**02. Chaise Time structure en bois de frêne orient, revêtement cat. b écocuir vintage 107.**  
 L 43 P 52 H 80/44 cm

**01. Stuhl Time Struktur Holz Thermoeiche, Bezug Kat. B Lederimitat Vintage 107.**  
**02. Stuhl Time Struktur Holz Esche Oriente, Bezug Kat. B Lederimitat Vintage 107.**  
 B. 43 T. 52 H. 80/44 cm



#### PAG 78

**Silla Betty**  
 01. cat. b ecopiel vintage 102.  
 02. cat. 1/one atom 34.  
 03. cat. b econobuk 12.  
 04. cat. b ecopiel 01.  
 05. cat. b econobuk 11.  
 06. cat. b ecopiel 15.  
 A 45 P 54 H 81/46 cm  
 Wallpaper WPT 535.  
 Wallpaper WPT 527.

**Chaise Betty**  
 01. cat. b écocuir vintage 102.  
 02. cat. 1/one atom 34.  
 03. cat. b éconubuk 12.  
 04. cat. b écocuir 01.  
 05. cat. b éconubuk 11.  
 06. cat. b écocuir 15.  
 L 45 P 54 H 81/46 cm  
 Papier peint WPT 535.  
 Papier peint WPT 527.

**Stuhl Betty**  
 01. Kat. B Lederimitat Vintage 102.  
 02. Kat. 1/One Atom 34.  
 03. Kat. B Econabuk 12.  
 04. Kat. B Lederimitat 01.  
 05. Kat. B Econabuk 11.

**06. Kat. B Lederimitat 15.**  
 B. 45 T. 54 H. 81/46 cm  
 Wallpaper WPT 535.  
 Wallpaper WPT 527.



#### PAG 81

**Silla Skinny**  
 01. cat. b ecopiel 16.  
 02. cat. b econobuk 02.  
 A 46 P 56 H 95/48 cm  
 Wallpaper WPT 512.

**Chaise Skinny**  
 01. cat. b écocuir 16.  
 02. cat. b éconubuk 02.  
 L 46 P 56 H 95/48 cm  
 Papier peint WPT 512.

**Stuhl Skinny**  
 01. Kat. B Lederimitat 16.  
 02. Kat. B Econabuk 02.  
 B. 46 T. 56 H. 95/48 cm  
 Wallpaper WPT 512.



#### PAG 82

**Silla Tiffany**  
 01. estructura madera lacada poro abierto pómez 252, revestimiento cat. d nubes 09.  
 02. estructura madera lacada poro abierto madreperla 224, revestimiento cat. b hugo 04.  
 03. estructura madera lacada poro abierto madreperla 224, revestimiento cat. b ecopiel vintage. 107  
 04. estructura madera lacada poro abierto antracita 260, revestimiento cat. b ecopiel vintage 102.  
 A 46 P 50 H 83/47 cm  
 Wallpaper WPT 511.

**Chaise Tiffany**  
 01. structure en bois laqué ponce 252 à pores ouverts, revêtement cat. d nubes 09.  
 02. structure en bois laqué nacre 224 à pores ouverts, revêtement cat. b hugo 04.  
 03. structure en bois laqué nacre 224 à pores ouverts, revêtement cat. b écocuir vintage. 107  
 04. structure en bois laqué anthracite 260 à pores ouverts, revêtement cat. b écocuir vintage 102.  
 L 46 P 50 H 83/47 cm  
 Papier peint WPT 511.

**Stuhl Tiffany**

**01. Struktur Holz offenporig lackiert Bimsstein 252, Bezug Kat. D Nubes 09.**  
**02. Struktur Holz offenporig lackiert Perlmutt 224, Bezug Kat. C Leinen Froissè 04.**  
**03. Struktur Holz offenporig lackiert Perlmutt 224, Bezug Kat. B Lederimitat Vintage 107.**  
**04. Struktur Holz offenporig lackiert Anthrazit 260, Bezug Kat. B Lederimitat Vintage 102.**  
 B. 46 T. 50 H. 83/47 cm  
 Wallpaper WPT 511.



#### PAG 85

**Silla Tiffany estructura madera lacada poro abierto antracita 260, revestimiento cat. b econobuk 07.**  
 A 46 P 50 H 83/47 cm

**Chaise Tiffany structure en bois laqué anthracite 260 à pores ouverts, revêtement cat. b éconubuk 07.**  
 L 46 P 50 H 83/47 cm

**Stuhl Tiffany Struktur Holz offenporig lackiert Anthrazit 260, Bezug Kat. B Econabuk 07.**  
 B. 46 T. 50 H. 83/47 cm



#### PAG 87

**Silla Tiffany Faldón en varios colores y tejidos.**  
 A 46 P 50 H 83/47 cm

**Chaise Tiffany Gonna housse en divers coloris et tissus.**  
 L 46 P 50 H 83/47 cm

**Stuhl Tiffany mit Husse in verschiedenen Farbe und Stoffvarianten.**  
 B. 46 T. 50 H. 83/47 cm



#### PAG 90

**Aparador Sir S04 estructura texturizado trenzado claro, elemento Sir texturizado roble termotrataado y base metal antracita 160.**  
 A 216 P 51 H 84 cm

**Buffet Sir S04 structure en texturé Intreccio clair, plateau à rebords Sir en texturé chêne thermo-traité et piètement en métal anthracite 160.**  
 L 216 P 51 H 84 cm

**Sideboard Sir S04 Struktur Rau Geflecht hell, Element Sir Rau Thermoeiche und Grundgestell Metall Anthrazit 160.**  
 B. 216 T. 51 H. 84 cm



#### PAG 93

**Aparador Sir S03 estructura texturizado trenzado claro, elemento Sir texturizado roble termotrataado y base metal antracita 160.**  
 A 216 P 51 H 66 cm  
 Colección Natural Style S.

**Buffet Sir S03 structure en texturé Intreccio clair, plateau à rebords Sir en texturé chêne thermo-traité et piètement en métal anthracite 160.**  
 L 216 P 60 H 66 cm  
 Collection Natural Style S.

**Sideboard Sir S03 Struktur Rau Geflecht hell, Element Sir Rau Thermoeiche und Grundgestell Metall Anthrazit 160.**  
 B. 216 T. 51 H. 66 cm  
 Kollektion Natural Style S.



#### PAG 94

**Aparador Sir S02 estructura lacado mate salvia 159, elemento Sir madera roble termotrataado.**  
 A 270 P 40 H 54 cm  
 Mesa Plinto sobre cristal transparente 320, estructura madera roble termotrataado y metal antracita 160.  
 A 240 P 110 H 75 cm  
 Sillas York estructura madera roble termotrataado, revestimiento cat. b econobuk 12.  
 A 47 P 61 H 92/48 cm  
 Alfombra Black & White.

**Buffet Sir S02 structure laquée sauge 159 mat, plateau à rebords Sir en bois de chêne thermo-traité.**  
 L 270 P 40 H 54 cm  
 Table Plinto plateau en verre transparent 320, structure en bois de chêne thermo-traité et métal anthracite 160.  
 L 240 P 110 H 75 cm  
 Chaises York structure en bois de chêne thermo-traité, revêtement cat. b éconubuk 12.  
 L 47 P 61 H 92/48 cm  
 Tapis Black & White.

**Sideboard Sir S02 Struktur matt lackiert Salbei 159, Element Sir Holz Thermoeiche.**  
 B. 270 T. 40 H. 54 cm  
 Tisch Plinto Platte transparentes Glas 320, Struktur Holz Thermoeiche und Metall Anthrazit 160.  
 B. 240 T. 110 H. 75 cm  
 Stuhl York Struktur Holz Thermoeiche, Bezug Kat. B Econabuk 12.  
 B. 47 T. 61 H. 92/48 cm  
 Teppich Black & White.



#### PAG 98

a la izquierda: **aparador Regolo R01 estructura lacado mate azafrán 158, aplicación texturizado con nudos oscuro y base metal azafrán 158.**  
 A 108 P 40 H 147 cm  
 a la derecha: **aparador Regolo R02 estructura texturizado mate madreperla, aplicación texturizado con nudos oscuro y base metal madreperla 124.**  
 A 108 P 40 H 147 cm

à gauche: **buffet Regolo R01 structure laquée safran 158 mat, bandeau en texturé chêne à nœuds foncé et piètement en métal safran 158.**  
 L 108 P 40 H 147 cm  
 à droite: **buffet Regolo R02 structure en texturé nacre mat, bandeau en texturé chêne à nœuds foncé et piètement en métal nacre 124.**  
 L 108 P 40 H 147 cm

Auf der linken Seite: **Sideboard Regolo R01 Struktur matt**



lackiert Safrangelb 158, Einsatz Rau astig dunkel und Grundgestell Metall Safrangelb 158.  
B. 108 T. 40 H. 147 cm  
Auf der rechten Seite: Sideboard Regolo R02 Struktur Rau matt Perlmutter, Einsatz Rau astig dunkel, Grundgestell Metall Perlmutter 124.  
B. 108 T. 40 H. 147 cm



#### PAG 101

Aparador Regolo R05 estructura texturizado mate madreperla, aplicación texturizado con nudos oscuro y base metal madreperla 124.  
A 180 P 51 H 93,5 cm  
Colección cuadros Loft Style S.  
Alfombra Frame.

Buffet Regolo R05 structure en texturé nacre mat, bandeau en texturé chêne à nœuds foncé et piètement en métal nacre 124.  
L 180 P 51 H 93,5 cm  
Collection Tableaux Loft Style S.  
Tapis Frame.

Sideboard Regolo R05 Struktur Rau matt Perlmutter, Einsatz Rau astig dunkel und Grundgestell Metall Perlmutter 124.  
B. 180 T. 51 H. 93,5 cm  
Bilderkollektion Loft Style S.  
Teppich Frame.



#### PAG 102

Aparadores Regolo R03 estructura texturizado mate blanco yeso, aplicación texturizado mate antracita.  
A 108 P 40 H 147,5 cm  
Silla Lola estructura madera roble termotratado, revestimiento cat. c lino froissé 123.  
A 55 P 53 H 81/47 cm

Buffets Regolo R03 structure en texturé blanc craie mat, bandeau en texturé anthracite mat.  
L 108 P 40 H 147,5 cm  
Chaise Lola structure en bois de chêne thermo-traité, revêtement cat.c lin froissé 123.  
L 55 P 53 H 81/47 cm

Sideboard Regolo R03 Struktur Rau matt Gipsweiß, Griffeneinsatz Rau matt Anthrazit.  
B. 108 T. 40 H. 147,5 cm  
Stuhl Lola Struktur Holz Thermoeiche, Bezug Kat. C Leinen Froissé 123.  
B. 55 T. 53 H. 81/47 cm



#### PAG 105

Aparador Regolo R06 estructura texturizado mate blanco yeso, aplicación texturizado fresno oriente y base metal antracita 160.  
A 216 P 51 H 93,5 cm

Buffet Regolo R06 structure en texturé blanc craie mat, bandeau en texturé frêne orient et piètement en métal anthracite 160.  
L 216 P 51 H 93,5 cm

Sideboard Regolo R06 Struktur Rau matt Gipsweiß, Einsatz Rau Esche Oriente und Grundgestell Metall Anthrazit 160.  
B. 216 T. 51 H. 93,5 cm



#### PAG 108

Aparador Remix X02 estructura texturizado mate madreperla, texturizado con nudos claro y metal antracita 160.  
A 162 P 51 H 85,5 cm  
Colección cuadros Natural Style M.

Buffet Remix X02 structure en texturé nacre mat, texturé chêne à nœuds clair et métal anthracite 160.  
L 162 P 51 H 85,5 cm  
Collection Tableaux Natural Style M.

Sideboard Remix X02 Struktur Rau matt Perlmutter, Rau astig hell und Metall Anthrazit 160.  
B. 162 T. 51 H. 85,5 cm  
Bilderkollektion Natural Style M.



#### PAG 111

Aparador Remix X01 estructura lacado mate azul niño 155 y salvia 159. Base metal antracita 160.  
A 108 P 40 H 129,5 cm

Buffet Remix X01 structure laquée mate coloris bleu pastel 155 et sauge 159. Piètement en métal anthracite 160.  
L 108 P 40 H 129,5 cm

Sideboard Remix X01 Struktur matt lackiert Pastellblau 155 und Salbei 159. Grundgestell Metall Anthrazit 160.  
B. 108 T. 40 H. 129,5 cm



#### PAG 113

Aparador Remix X05 estructura texturizado cemento claro, elemento Sir madera fresno oriente y metal antracita 160.  
A 180 P 51 H 84 cm  
Colección cuadros Elegance Style M.

Buffet Remix X05 structure en texturé ciment clair, plateau à rebords Sir en bois de frêne orient et piètement en métal anthracite 160.  
L 180 P 51 H 84 cm  
Collection Tableaux Elegance Style M.

Sideboard Remix X05 Struktur Rau Zement hell, Element Sir Holz Esche Oriente und Metall Anthrazit 160.  
B. 180 T. 51 H. 84 cm  
Bilderkollektion Elegance Style M.



#### PAG 116

Aparador Metropolis A03 texturizado trenzado claro y metal antracita 160.  
A 180 P 51 H 85,5 cm  
Colección cuadros Elegance Style S.  
Alfombra Dots.

Buffet Metropolis A03 en texturé Intreccio clair et en métal anthracite 160.  
L 180 P 51 H 85,5 cm  
Collection Tableaux Elegance Style S.  
Tapis Dots.

Sideboard Metropolis A03 Rau Geflecht hell und Metall Anthrazit 160.  
B. 180 T. 51 H. 85,5 cm  
Bilderkollektion Elegance Style S.  
Teppich Dots.



#### PAG 121

Aparador Metropolis B01 estructura texturizado roble termotratado, base metal antracita 160.  
A 180 P 51 H 85,5 cm  
Wallpaper WPT 513.

Buffet Metropolis B01 structure en texturé chêne thermo-traité, piètement en métal anthracite 160.  
L 180 P 51 H 85,5 cm  
Papier peint WPT 513.

Sideboard Metropolis B01 Struktur Rau Thermoeiche, Grundgestell Metall Anthrazit 160.  
B. 180 T. 51 H. 85,5 cm  
Wallpaper WPT 513.



#### PAG 122

Aparador Metropolis A02 estructura texturizado roble termotratado, base metal antracita 160.  
A 108 H 157,5 P 40 cm

Buffet Metropolis structure en texturé chêne thermo-traité, piètement en métal anthracite 160.  
L 108 H 157,5 P 40 cm

Sideboard Metropolis Struktur Rau Thermoeiche, Grundgestell Metall Anthrazit 160.  
B. 108 H. 157,5 T. 40 cm



#### PAG 123

Aparador Metropolis A06 estructura texturizado roble termotratado, base metal antracita 160.  
A 216 P 51 H 85,5 cm  
Colección cuadros Contemporary Style L.  
Alfombra Gradient.

Buffet Metropolis A06 structure en texturé chêne thermo-traité, piètement en métal anthracite 160.  
L 216 P 51 H 85,5 cm  
Collection Tableaux Contemporary Style L.  
Tapis Gradient.

Sideboard Metropolis A06 Struktur Rau Thermoeiche, Grundgestell Metall Anthrazit 160.  
B. 216 T. 51 H. 85,5 cm  
Bilderkollektion Contemporary Style L.  
Teppich Gradient.



#### PAG 124

Aparador Metropolis A02 estructura lacado mate salvia 159, base metal antracita 160.  
A 216 P 51 H 85,5 cm  
Colección cuadros Contemporary Style S.

Buffet Metropolis A02 structure laquée sauge 159 mat, piètement en métal anthracite 160.  
L 216 P 51 H 85,5 cm  
Collection Tableaux Contemporary Style S

Sideboard Metropolis A02 Struktur matt lackiert Salbei 159, Grundgestell Metall Anthrazit 160.  
B. 216 T. 51 H. 85,5 cm  
Bilderkollektion Contemporary Style S.



#### PAG 126

Aparador Metropolis A04 estructura lacado mate azul niño 155, base metal antracita 160.  
A 216 P 51 H 85,5 cm  
Wallpaper WPT 550.

Buffet Metropolis A04 structure laquée bleu pastel 155 mat, piètement en métal anthracite 160.  
L 216 P 51 H 85,5 cm  
Papier peint WPT 550.

Sideboard Metropolis A04 Struktur matt lackiert Pastellblau 155. Grundgestell Metall Anthrazit 160.  
B. 216 T. 51 H. 85,5 cm  
Wallpaper WPT 550.





PAG 128

Aparador Metropolis C01 texturizado mate madreperla y texturizado fresno oriente, base metal antracita 160. A 144 P 51 H 121,5 cm

Buffet Metropolis C01 en texturé nacre mat et texturé frêne orient, piètement en métal anthracite 160. L 144 P 51 H 121,5 cm

Sideboard Metropolis C01 Rau matt Perlmutt und Rau Esche Oriente, Grundgestell Anthrazit 160. B. 144 T. 51 H. 121,5 cm



PAG 129

Aparador Metropolis A03 estructura lacado mate blanco yeso 121, base metal antracita 160. A 216 P 51 H 85,5 cm Colección cuadros Elegance Style M.

Buffet Metropolis A03 structure laquée blanc craie 121 mat, piètement en métal anthracite 160. L 216 P 51 H 85,5 cm Collection Tableaux Elegance Style M.

Sideboard Metropolis A03 Struktur matt lackiert Gipsweiß 121, Grundgestell Metall Anthrazit 160. B. 216 T. 51 H. 85,5 cm Bilderkollektion Elegance Style M.



PAG 130

Aparador Metropolis A01 estructura lacado mate blanco yeso 121 y smoke 128. Base metal antracita 160. A 216 P 51 H 85 cm Alfombra Frame. Wallpaper WPT 512.

Buffet Metropolis A01 structure laquée mate coloris blanc craie 121 et smoke 128. Piètement en métal anthracite 160. L 216 P 51 H 85 cm Tapis Frame. Papier peint WPT 512.

Sideboard Metropolis A01 Struktur matt lackiert Gipsweiß 121 und Smoke 128. Grundgestell Metall Anthrazit 160. B. 216 T. 51 H. 85 cm Teppich Frame. Wallpaper WPT 512.



PAG 134

Aparador Diagonal Var. A estructura texturizado fresno oriente, metal blanco yeso 121. A 219 P 51 H 85,5 cm Estantes Ring texturizado fresno oriente, metal blanco yeso 121. A 144 P 26 H 27 cm Butaca Loft estructura madera fresno oriente, revestimiento cat. c linara 31. A 59 P 70 H 64 cm Puf Guccino revestimiento cat. c linara 30 y lacado mate blanco yeso 121. Ø 40 H 53 cm Alfombra Diagonal.

Buffet Diagonal Var. A structure en texturé frêne orient, piètement en métal blanc craie 121. L 219 P 51 H 85,5 cm Étagères Ring en texturé frêne orient, anneaux en métal blanc craie 121. L 144 P 26 H 27 cm Fauteuil Loft structure en bois de frêne orient, revêtement cat.c linara 31. L 59 P 70 H 64 cm Pouf Guccino revêtement cat.c linara 30 et laquée blanc craie 121 mat. Ø 40 H 53 cm Tapis Diagonal.

Sideboard Diagonal Variante A Struktur Rau Esche Oriente, Metall Gipsweiß 121. B. 219 T. 51 H. 85,5 cm Borde Ring Rau Esche Oriente, Metall Gipsweiß 121. B. 144 T. 26 H. 27 cm Sessel Loft Struktur Holz Esche Oriente, Bezug Kat. C Linara 31. B. 59 T. 70 H. 64 cm

Hocker Guccino Bezug Kat. C Linara 30 und matt lackiert Gipsweiß 121. Ø 40 H. 53 cm Teppich Diagonal.



PAG 138

Aparador Diagonal Var. B estructura texturizado mate blanco yeso, texturizado fresno oriente, metal smoke 128. A 219 P 51 H 85,5 cm Butaca Loft estructura madera roble termotratado, revestimiento cat. b econobuk 07. A 59 P 70 H 64 cm

Buffet Diagonal Var.B structure en texturé blanc craie mat, texturé frêne orient, métal smoke 128. L 219 P 51 H 85,5 cm Fauteuil Loft structure en bois de chêne thermo-traité, revêtement cat.b éconobuk 07. L 59 P 70 H 64 cm

Sideboard Diagonal Variante B Struktur Rau matt Gipsweiß, Rau Esche Oriente, Metall Smoke 128. B. 219 T. 51 H. 85,5 cm Sessel Loft Struktur Holz Thermoeiche, Bezug Kat. B Econobuk 07. B. 59 T. 70 H. 64 cm



PAG 141

Aparador Diagonal Var. A estructura texturizado roble termotratado, compartimento abierto metal madreperla 124 y base metal antracita 160. A 219 P 51 H 85,5 cm Silla Lola estructura madera roble termotratado, revestimiento cat. b ecopiel vintage 107. A 55 P 53 H 81/47 cm

Buffet Diagonal Var.A structure en texturé chêne thermo-traité, élément ouvert en métal nacre 124 et piètement en métal anthracite 160. L 219 P 51 H 85,5 cm Chaise Lola structure en bois de chêne thermo-traité, revêtement cat.b écocuir vintage 107. L 55 P 53 H 81/47 cm

Sideboard Diagonal Variante A Struktur Rau Thermoeiche, offenes Abteil Metall Perlmutt 124 und Grundgestell Metall Anthrazit 160. B. 219 T. 51 H. 85,5 cm Stuhl Lola Struktur Holz Thermoeiche, Bezug Kat. B Lederimitat Vintage 107. B. 55 T. 53 H. 81/47 cm



PAG 143

Aparador Diagonal estructura texturizado mate blanco yeso y texturé chêne à nœuds foncé, compartimentos abiertos metal antracita 160. A 183 P 51 H 111,5 cm

Buffet Diagonal structure en texturé blanc craie mat et texturé chêne à nœuds foncé, éléments ouverts en métal anthracite 160. L 183 P 51 H 111,5 cm

Sideboard Diagonal Struktur Rau matt Gipsweiß und Rau astig dunkel, offene Abteile Metall Anthrazit 160. B. 183 T. 51 H. 111,5 cm



PAG 144

Aparador Diagonal Var. B estructura texturizado mate blanco yeso y texturizado con nudos oscuro. Compartimentos abiertos y base metal antracita 160. A 219 P 51 H 85,5 cm Panel Krea decoración 411. A 144 P 22 H 144 cm Colección cuadros Colors Style XS. Alfombra Stripes.

Buffet Diagonal Var.B structure en texturé blanc craie mat et texturé chêne à nœuds foncé. Éléments ouverts et piètement en métal anthracite 160. L 219 P 51 H 85,5 cm Panneau mural Krea décor graphique 411. L 144 P 22 H 144 cm Collection Tableaux Colors Style XS. Tapis Stripes.

Sideboard Diagonal Variante B Struktur Rau matt Gipsweiß und Rau astig dunkel. Offene Abteile und Grundgestell Metall Anthrazit 160. B. 219 T. 51 H. 85,5 cm Paneel Krea mit Grafikmuster 411. B. 144 T. 22 H. 144 cm Bilderkollektion Colors Style XS. Teppich Stripes.



PAG 150

Madia Athena 3 ante struttura materico frassino oriente, inserti laccato opaco antracite 160 e basamento metallo antracite 160. L 181 P 51 H 85 cm Pensile Ciko metallo antracite 160 e specchio argentato 381. L 36 P 24 H 36 cm Wallpaper WPT 553.

Buffet Athena 3 portes, structure en texturé frêne orient, bandeaux laqués anthracite 160 mat et piètement en métal anthracite 160. L 181 P 51 H 85 cm Élément haut Ciko en métal anthracite 160 et miroir argenté 381. L 36 P 24 H 36 cm Papier peint WPT 553.

Sideboard Athena 3 Türen Struktur Rau Esche Oriente, Einsätze matt lackiert Anthrazit 160 und Grundgestell Metall Anthrazit 160. B. 181 T. 51 H. 85 cm Wandelement Ciko Metall Anthrazit 160 und Spiegel in Silberoptik 381. B. 36 T. 24 H. 36 cm Wallpaper WPT 553.



PAG 152

Aparador Athena detalle puertas estructura texturizado roble termotratado, aplicaciones mosaico marrón.

Buffet Athena avec portes au premier plan, structure en texturé chêne thermo-traité, bandeaux en mosaïque marron.

Sideboard Athena Detail der Türen Struktur Rau Thermoeiche, Einsätze Mosaik Braun.



PAG 153

Aparador Athena 3 puertas estructura texturizado roble termotratado, aplicaciones texturizado mate madreperla y base metal madreperla 124. A 181 P 51 H 85 cm Alfombra Frame.

Buffet Athena 3 portes, structure en texturé chêne thermo-traité, bandeaux en texturé nacre mat et piètement en métal nacre 124. L 181 P 51 H 85 cm Tapis Frame.

Sideboard Athena 3 Türen Struktur Rau Thermoeiche, Einsätze Rau matt Perlmutt und Grundgestell Metall Perlmutt 124. B. 181 T. 51 H. 85 cm Teppich Frame.



PAG 154

Aparador Athena 3 puertas estructura lacado mate pómez 152, aplicaciones cristal antracita 360, base metal antracita 160. A 181 P 51 H 85 cm

Buffet Athena 3 portes, structure laquée ponce 152 mat, bandeaux en verre anthracite 360, piètement en métal anthracite 160. L 181 P 51 H 85 cm

Sideboard Athena 3 Türen Struktur matt lackiert Bimsstein 152, Einsätze Glas Anthrazit 360, Grundgestell Metall Anthrazit 160. B. 181 T. 51 H. 85 cm





#### PAG 157

Aparador Athena 4 puertas estructura lacado mate azul niño 155, aplicaciones texturizado fresno oriente, base metal azul niño 155.  
A 121 P 51 H 141 cm  
Lettering City metal antracita 160.  
A 42 H 80 cm  
Reloj 650.

Buffet Athena 4 portes, structure laquée bleu pastel 155 mat, bandeaux en texturé frêne orient, piètement en métal bleu pastel 155.  
L 121 P 51 H 141 cm  
Lettering City en métal anthracite 160.  
L 42 H 80 cm  
Horloge 650.

Sideboard Athena 4 Türen Struktur matt lackiert Pastellblau 155, Einsätze Rau Esche Oriente, Grundgestell Metall Pastellblau 155.  
B. 121 T. 51 H. 141 cm  
Lettering City Metall Anthrazit 160.  
B. 42 H. 80 cm  
Uhr 650.



#### PAG 160

Aparador Madison estructura lacado mate antracita 160.  
A 207 P 49 H 76 cm  
Mesita 33 versión 13. Ø 40 H 38 cm

Buffet Madison structure laquée anthracite 160 mat.  
L 207 P 49 H 76 cm  
Table basse 33 version 13. Ø 40 H 38 cm

Sideboard Madison Struktur matt lackiert Anthrazit 160.  
B. 207 T. 49 H. 76 cm  
Beistelltisch 33 Version 13. Ø 40 H. 38 cm



#### PAG 163

Aparador Madison estructura lacado mate blanco yeso 121.  
A 207 P 49 H 76 cm  
Colgante Ciko metal antracita 160, decoración 260 y 235 y lacado mate salvia 159.  
A 36 P 24 H 36 cm  
Reloj 630.

Buffet Madison structure laquée blanc craie 121 mat.  
L 207 P 49 H 76 cm  
Élément haut Ciko en métal anthracite 160, décors graphiques 260, 235 et laqué sauge 159 mat.  
L 36 P 24 H 36 cm  
Horloge 630.

Sideboard Madison Struktur matt lackiert Gipsweiß 121.  
B. 207 T. 49 H. 76 cm  
Wandelement Ciko Metall Anthrazit 160, Grafikmuster 260, 235, und matt lackiert Salbei 159.  
B. 36 T. 24 H. 36 cm  
Uhr 630.



#### PAG 164

Aparador Atlante lacado mate smoke 128 y espejo gris satinado 383.  
A 240 P 54 H 76 cm  
Silla Lolita estructura roble termotratado, revestimiento cat. b hugo 04.  
A 51 P 56 H 79/47 cm

Buffet Atlante laqué smoke 128 mat et miroir gris satiné 383.  
L 240 P 54 H 76 cm  
Chaise Lolita structure en chêne thermo-traité, revêtement cat.b hugo 04.  
L 51 P 56 H 79/47 cm

Sideboard Atlante matt lackiert Smoke 128 und Spiegel Grau satiniert 383.  
B. 240 T. 54 H. 76 cm  
Stuhl Lolita Struktur Thermoeiche. Bezug Kat. B Hugo 04.  
B. 51 T. 56 H. 79/47 cm



#### PAG 167

Aparador Atlante madera lacada poro abierto hot 127 y espejo gris satinado 393.  
A 192 P 54 H 76 cm  
Alfombra Frame.

Buffet Atlante en bois laqué hot 127 à pores ouvert et miroir gris satiné 393.  
L 192 P 54 H 76 cm  
Tapis Frame.

Sideboard Atlante Holz offenporig lackiert Hot 127 und Spiegel Grau satiniert 393.  
B. 192 T. 54 H. 76 cm  
Teppich Frame.

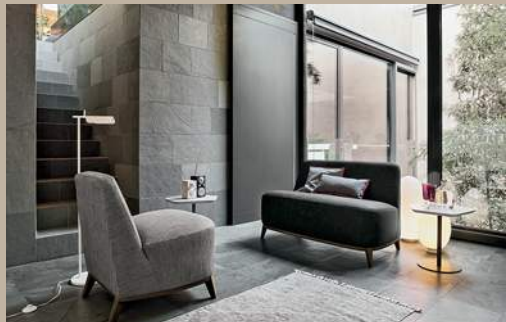

#### PAG 170

Butaca Loft estructura madera roble termotratado, revestimiento cat. b joy.  
A 59 P 70 H 64 cm

Sofá Loft estructura madera roble termotratado, revestimiento cat. b econobuk 5.

A 124 P 75 H 70 cm  
Mesita Caruso sobre lacado mate blanco yeso 121, base metal antracita 160.  
A 44 P 44 H 43 cm

Fauteuil Loft structure en bois de chêne thermo-traité, revêtement cat.b joy.  
L 59 P 70 H 64 cm

Petit canapé Loft structure en bois de chêne thermo-traité, revêtement cat.b econobuk 5.

L 124 P 75 H 70 cm  
Table basse Caruso plateau laqué blanc craie 121 mat, piètement en métal anthracite 160.  
L 44 P 44 H 43 cm

Sessel Loft Struktur Holz Thermoeiche, Bezug Kat. B Joy.  
B. 59 T. 70 H. 64 cm  
Kleines Sofa Loft Struktur Holz Thermoeiche, Bezug Kat. B Econobuk 5.  
B. 124 T. 75 H. 70 cm  
Beistelltisch Caruso Platte matt lackiert Gipsweiß 121, Grundgestell Metall Anthrazit 160.  
B. 44 T. 44 H. 43 cm



#### PAG 172

Butaca Loft estructura madera roble termotratado, revestimiento cat. b econobuk 5.  
A 59 P 70 H 64 cm  
Mesita Brigitte lacado mate antracita 160 y metal antracita 160.  
Ø 45 H 52 cm

Fauteuil Loft structure en bois de chêne thermo-traité, revêtement cat.b econobuk 5.  
L 59 P 70 H 64 cm  
Table basse Brigitte laquée anthracite 160 mat et en métal anthracite 160.  
Ø 45 H 52 cm

Sessel Loft Struktur Holz Thermoeiche, Bezug Kat. B Econobuk 5.  
B. 59 T. 70 H. 64 cm  
Beistelltisch Brigitte matt lackiert Anthrazit 160 und Metall Anthrazit 160.  
Ø 45 H. 52 cm



#### PAG 175

Sofá Loft estructura madera fresno oriente, revestimiento cat. b econobuk 5.  
A 124 P 75 H 70 cm  
Wallpaper WPT535.

Petit canapé Loft structure en bois de frêne orient, revêtement cat.b econobuk 5.  
L 124 P 75 H 70 cm  
Papier peint WPT 535.

Kleines Sofa Loft Struktur Holz Esche Oriente, Bezug Kat. B Econobuk 5.  
B. 124 T. 75 H. 70 cm  
Wallpaper WPT535.



#### PAG 176

Butaca Flower  
01. cat. 1/one easy 20/hilo 3426.  
02. cat. 1/one easy 18/hilo 877.  
03. cat. 1/one point 16/hilo 0856.  
A 85 P 75 H 75/40 cm

Fauteuil Flower  
01. cat. 1/one easy 20/fil 3426.  
02. cat. 1/one easy 18/fil 877.  
03. cat. 1/one point 16/fil 0856.  
L 85 P 75 H 75/40 cm

Sessel Flower  
01. Kat. 1/One Easy 20/Ziernaht 3426.  
02. Kat. 1/One Easy 20/Ziernaht 877.  
03. Kat. 1/One Point 16/Ziernaht 0856.  
B. 85 T. 75 H. 75/40 cm



#### PAG 179

Butaca Flower cat. f piel vintage 102.  
A 85 P 75 H 75/40 cm  
Mesita Joy Decor sobre decoración 150, base metal antracita 160.  
Ø 45 H 46 cm  
Wallpaper WPT550.

Fauteuil Flower cat.f cuir vintage 102.  
L 85 P 75 H 75/40 cm  
Table basse Joy Decor plateau avec décor graphique 150, piètement en métal anthracite 160.  
Ø 45 H 46 cm  
Papier peint WPT 550.

Sessel Flower Kat. F Leder Vintage 102.  
B. 85 T. 75 H. 75/40 cm  
Beistelltisch Joy Decor Platte Grafikmuster 150, Grundgestell Metall Anthrazit 160.  
Ø 45 H. 46 cm  
Wallpaper WPT550.



#### PAG 180

Butaca Soft  
01. cat. d lino froissé 123.  
02. cat. d lino froissé 05.  
03. cat. d lino froissé 100.  
04. cat. d lino froissé 116.  
A 66 P 95 H 72/41 cm  
Mesita Joy sobre texturizado con nudos claro, base metal antracita 160.  
Ø 60 H 38 cm  
Alfombra Frame.

Fauteuil Soft  
01. cat. d lin froissé 123.  
02. cat. d lin froissé 05.  
03. cat. d lin froissé 100.  
04. cat. d lin froissé 116.  
L 66 P 95 H 72/41 cm  
Table basse Joy plateau en texturé chêne à nœuds clair, piètement en métal anthracite 160.  
Ø 60 H 38 cm  
Tapis Frame.

Sessel Soft  
01. Kat. D Leinen Froissé 123.  
02. Kat. D Leinen Froissé 05.  
03. Kat. D Leinen Froissé 100.  
04. Kat. D Leinen Froissé 116.  
B. 66 T. 95 H. 72/41 cm  
Beistelltisch Joy Platte Rau astig hell, Grundgestell Metall Anthrazit 160.  
Ø 60 H. 38 cm  
Teppich Frame.



#### PAG 183

Butaca Soft cat. d lino froissé 011.  
A 66 P 95 H 72/41 cm  
Mesita Joy Decor sobre decoración 111, base metal azafrán 158.  
Ø 45 H 46 cm

Fauteuil Soft cat.d lin froissé 011.  
L 66 P 95 H 72/41 cm  
Table basse Joy Decor plateau avec décor graphique 111, piètement en métal safran 158.  
Ø 45 H 46 cm

Sessel Soft Kat.D Leinen Froissé 011.



B. 66 T. 95 H. 72/41 cm  
Beistelltisch Joy Decor Platte Grafikmuster 111, Grundgestell Metall Safrangelb 158.  
Ø 45 H. 46 cm



#### PAG 184

Butaca Maya cat. b ecopiel vintage 101 y cat. d linara 13.  
A 72 P 84 H 79/43 cm  
Mesita Caruso metal blanco yeso 121.  
A 44 P 44 H 43 cm  
Banco Panketta texturizado con nudos claro, estructura metal antracita 160.  
A 216 P 38 H 45 cm  
Raster metal blanco yeso 121 y texturizado con nudos claro.  
A 144 P 30 H 18 cm  
Manta Cuzco.  
Wallpaper WPT527.

Fauteuil Maya cat.b écocuir vintage 101 et cat.d linara 13.  
L 72 P 84 H 79/41 cm  
Table basse Caruso en métal blanc craie 121.  
L 44 P 44 H 43 cm  
Panketta en texturé chêne à nœuds clair, structure en métal anthracite 160.  
L 216 P 38 H 45 cm  
Casier Raster en métal blanc craie 121 et texturé chêne à nœuds clair.  
L 144 P 30 H 18 cm  
Plaid Cuzco.  
Papier peint WPT 527.

Sessel Maya Kat. B Lederimitat Vintage 101 und Kat. D Linara 13.  
B. 72 T. 84 H. 79/41 cm  
Beistelltisch Caruso Metall matt lackiert Gipsweiß 121.  
B. 44 T. 44 H. 43 cm  
Panketta Platte Rau astig hell, Struktur Metall Anthrazit 160.  
B. 216 T. 38 H. 45 cm  
Element Raster Metall Gipsweiß 121 und Rau astig hell.  
B. 144 T. 30 H. 18 cm  
Plaid Cuzco.  
Wallpaper WPT527.



#### PAG 187

Butaca Maya cat. b ecopiel vintage 107, cat.1/one easy 21.  
A 72 P 84 H 79/43  
Mesita Brigitte lacado mate antracita 160.  
Ø 45 H 52 cm

Fauteuil Maya cat.b écocuir vintage 107 et cat.1/one easy 21.  
L 72 P 84 H 79/43  
Table basse Brigitte laquée anthracite 160 mat.  
Ø 45 H 52 cm

Sessel Maya Kat. B Lederimitat Vintage 101, Kat. 1/One Easy 21.  
B. 72 T. 84 H. 79/43  
Beistelltisch Brigitte matt lackiert Anthrazit 160.  
Ø 45 H. 52 cm



#### PAG 189

Butaca Vanessa cat. c lino froissé 011.  
A 64 P 64 H 90/50 cm  
Mesita Caruso lacado mate blanco yeso 121.  
A 44 P 44 H 43 cm  
Manta Lino saco.  
A 150 P 195 cm

Fauteuil Vanessa cat. c lin froissé 011.  
L 64 P 64 H 90/50 cm  
Table basse Caruso laquée blanc craie 121 mat.  
L 44 P 44 H 43 cm  
Plaid Lino sacco.  
L 150 P 195 cm

Sessel Vanessa Kat. C Leinen Froissé 011.  
B. 64 T. 64 H. 90/50 cm  
Beistelltisch Caruso matt lackiert Gipsweiß 121.  
B. 44 T. 44 H. 43 cm  
Plaid Leinen Sacco  
B. 150 L. 195 cm



#### PAG 191

Butaca Linda cat. 1/one atom 34.  
A 67 P 67 H 75 cm  
Mesita Brigitte sobre texturizado cemento claro, estructura metal hot 127.  
ø 45 H 52 cm

Fauteuil Linda cat. 1/one atom 34.  
L 67 P 67 H 75 cm  
Table basse Brigitte plateau en texturé ciment clair, structure en métal hot 127.

Ø 45 H 52 cm

Sessel Linda Kat. 1/One Atom 34.  
B. 67 T. 67 H. 75 cm

Beistelltisch Brigitte Platte Rau Zement hell, Struktur Metall Hot 127.  
Ø 45 H. 52 cm



#### PAG 195

Cookie Puf con revestimiento en varios tejidos.

Cookie Pouf avec revêtement en différents tissus.

Cookie Hocker mit Bezug in verschiedenen Stoffvarianten B.

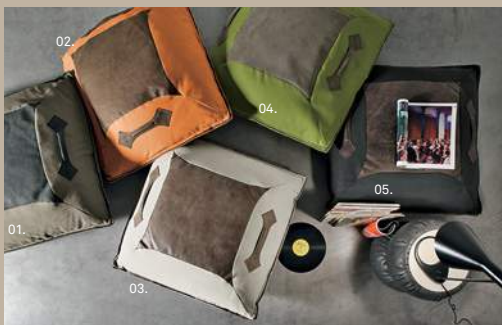

#### PAG 196

Giglio 01.  
cat. 1/one point 28/ cat. b ecopiel vintage 107.  
Giglio 02.  
cat. c lino froissé 006/ cat. b ecopiel vintage 103.  
Giglio 03.  
cat. 1/one point 01/ cat. b ecopiel vintage 103.  
Giglio 04.  
cat. c lino froissé 015/ cat. b ecopiel vintage 102.  
Giglio 05.  
cat. 1/one point 16/ cat. b ecopiel vintage 106.

Giglio 01.  
cat. 1/one point 28/ cat. b écocuir vintage 107.  
Giglio 02.  
cat.c lin froissé 006/ cat. b écocuir vintage 103.  
Giglio 03.  
cat. 1/one point 01/ cat. b écocuir vintage 103.  
Giglio 04.  
cat.c lin froissé 015/ cat. b écocuir vintage 102.  
Giglio 05.  
cat. 1/one point 16/ cat. b écocuir vintage 106.

Giglio 01.  
Kat. 1/One Point 28/ Kat. B Lederimitat Vintage 107.  
Giglio 02.  
Kat. C Leinen Froissé 006 / Kat. B Lederimitat Vintage 103.  
Giglio 03.  
Kat. 1/One Point 01/ Kat. B Lederimitat Vintage 103.  
Giglio 04.  
Kat. C Leinen Froissé 015 / Kat. B Lederimitat Vintage 102.  
Giglio 05.  
Kat. 1/One Point 16/ Kat. B Lederimitat Vintage 106.



#### PAG 197

Giglio 06.  
cat. 1/one point 01/ cat. b ecopiel vintage 102.  
Giglio 07.  
cat. 1/one point 28/ cat. b ecopiel vintage 107.  
Giglio 08.  
cat. 1/one point 11/ cat. b ecopiel vintage 103.  
Giglio 09.  
cat. 1/one point 16/ cat. b ecopiel vintage 106.

Giglio 06.  
cat. 1/one point 01/ cat.b écocuir vintage 102.  
Giglio 07.  
cat. 1/one point 28/ cat.b écocuir vintage 107.  
Giglio 08.  
cat. 1/one point 11/ cat.b écocuir vintage 103.  
Giglio 09.  
cat. 1/one point 06/ cat.b écocuir vintage 103.

Giglio 06.  
Kat. 1/One Point 01/ Kat. B Lederimitat Vintage 102.  
Giglio 07.  
Kat. 1/One Point 28/ Kat. B Lederimitat Vintage 107.  
Giglio 08.  
Kat. 1/One Point 11/ Kat. B Lederimitat Vintage 103.  
Giglio 09.  
Kat. 1/One Point 06/ Kat. B Lederimitat Vintage 103.



#### PAG 199

Puf Guccino  
lacado mate madreperla 124, cat. c linara 16.  
lacado mate madreperla 124, cat. c linara 03.  
Ø 40 H 53 cm

Pouf Guccino  
laqué nacre 124 mat, cat.c linara 16.  
laqué nacre 124 mat, cat.c linara 03.  
Ø 40 H 53 cm

Hocker Guccino matt lackiert Perlmutt 124, Kat. C Linara 16.  
matt lackiert Perlmutt 124, Kat. C Linara 03.  
Ø 40 H. 53 cm



#### PAG 200

Comodo 01.  
cat. 1/one easy 18, hilo 877.  
Comodo 02.  
cat. c lino froissé 100 y 033, hilo 877.  
Comodo 03.  
cat. b ecopiel vintage 107, hilo 877.  
Comodo 04.  
cat. b texas 28, hilo 877.  
Comodo 05.  
cat. b texas 31 y 12, hilo 877.  
Comodo 06.  
cat. 1/one easy 20, hilo 3426.  
L 85 P 85 H 85 cm  
Libreria Movida estructura metal blanco yeso 121, estantes texturizado con nudos claro.  
A 74 P 38 H 190 cm  
Alfombra Gradient.

Comodo 01.  
cat.1/one easy 18, fil 877.  
Comodo 02.  
cat.c lin froissé 100 et 033, fil 877.  
Comodo 03.  
cat.b écocuir vintage 107, fil 877.  
Comodo 04.  
cat.b texas 28, fil 877.  
Comodo 05.  
cat.b texas 31 et 12, fil 877.  
Comodo 06.  
cat. 1/one easy 20, fil 3426.  
L 85 P 85 H 85 cm  
Bibliothèque Movida structure en métal blanc craie 121, tablettes en texturé chêne à nœuds clair.  
L 74 P 38 H 190 cm  
Tapis Gradient.

Comodo 01.  
Kat. 1/One Easy 18, Ziernaht 877.  
Comodo 02.  
Kat. C Leinen Froissé 100 und 033, Ziernaht 877.  
Comodo 03.  
Kat. B Lederimitat Vintage 107, Ziernaht 877.  
Comodo 04.  
Kat. B Texas 28, Ziernaht 877.  
Comodo 05.  
Kat. B Texas 31 und 12, Ziernaht 877.  
Comodo 06.  
Kat. 1/One Easy 20, Ziernaht 3426.  
L 85 P 85 H 85 cm  
Bücherregal Movida, Struktur Metall Gipsweiß 121, Fachböden Rau astig hell.  
B. 74 T. 38 H. 190 cm  
Teppich Gradient.



#### PAG 204

Mesita Joy  
01. sobre texturizado cemento claro, estructura metal peltre.  
Ø 100 H 26 cm  
02. sobre texturizado con nudos oscuro, estructura metal peltre. Ø 60 H 39 cm  
03. sobre lacado mate blanco yeso 121, estructura metal peltre. Ø 100 H 26 cm  
04. sobre texturizado cemento oscuro, estructura metal peltre. Ø 60 H 39 cm  
05. sobre texturizado con nudos claro, estructura metal blanco yeso 121. Ø 100 H 26 cm  
06. sobre lacado mate blanco yeso 121, estructura metal blanco yeso 121. Ø 100 H 26 cm

Table basse Joy  
01. plateau en texturé ciment clair, structure en métal étain.  
Ø 100 H 26 cm  
02. plateau en texturé chêne à nœuds foncé, structure en métal étain. Ø 60 H 39 cm  
03. plateau laqué blanc craie 121 mat, structure en métal étain. Ø 100 H 26 cm  
04. plateau en texturé ciment foncé, structure en métal étain. Ø 60 H 39 cm  
05. plateau en texturé chêne à nœuds clair, structure en métal blanc craie 121. Ø 100 H 26 cm  
06. plateau laqué blanc craie 121 mat, structure en métal blanc craie 121. Ø 100 H 26 cm

Beistelltisch Joy  
01. Platte Rau Zement hell, Struktur Metall Zinn. Ø 100 H. 26 cm  
02. Platte Rau astig dunkel, Struktur Metall Zinn. Ø 60 H. 39 cm  
03. Platte matt lackiert Gipsweiß 121, Struktur Metall Zinn. Ø 100 H. 26 cm  
04. Platte Rau Zement dunkel, Struktur Metall Zinn. Ø 60 H. 39 cm  
05. Platte Rau astig hell, Struktur Metall Gipsweiß 121. Ø 100 H. 26 cm  
06. Platte matt lackiert Gipsweiß 121, Struktur Metall Gipsweiß 121. Ø 100 H. 26 cm



#### PAG 207

Mesita Joy  
01. sobre texturizado cemento claro, estructura metal antracita 160.  
Ø 100 H 26 cm  
02. sobre texturizado con nudos claro, estructura metal antracita 160.  
Ø 60 H 39 cm  
03. sobre texturizado cemento oscuro, estructura metal antracita 160.  
Ø 45 H 47 cm  
Alfombra Gradient.

Table basse Joy  
01. plateau en texturé ciment clair, structure en métal anthracite 160.  
Ø 100 H 26 cm  
02. plateau en texturé chêne à nœuds clair, structure en métal anthracite 160.  
Ø 60 H 39 cm  
03. plateau en texturé ciment foncé, structure en métal anthracite 160.  
Ø 45 H 47 cm  
Tapis Gradient.



Beistelltisch Joy  
 01. Platte Rau Zement hell, Struktur Metall Anthrazit 160.  
 Ø 100 H. 26 cm  
 02. Platte Rau Zement hell, Struktur Metall Anthrazit 160.  
 Ø 60 H. 39 cm  
 03. Platte Rau Zement dunkel, Struktur Metall Anthrazit 160.  
 Ø 45 H. 47 cm  
 Teppich Gradient.



#### PAG 209

Mesita Joy decor varios colores de estructura y 19 decoraciones creativas distintas para el sobre.

Table basse Joy Decor structure en différents coloris et 19 décors créatifs pour le plateau.

Beistelltisch Joy Decor Struktur in mehreren Farben und 19 verschiedene kreative Grafikmuster für die Platte.



#### PAG 211

Mesita Joy Wood  
 01. sobre madera roble, estructura metal blanco yeso 121.  
 Ø 60 H 38 cm  
 02. sobre madera nogal negro, estructura metal antracita 160.  
 Ø 45 H 46 cm

Table basse Joy Wood  
 01. plateau en bois de chêne, structure en métal blanc craie 121.  
 Ø 60 H 38 cm  
 02. plateau en bois de noyer noir, structure en métal anthracite 160.  
 Ø 45 H 46 cm

Beistelltisch Joy Wood  
 01. Platte Eichenholz, Struktur Metall Gipsweiß 121.  
 Ø 60 H. 38 cm  
 02. Platte Holz Nussbaum Canaletto, Struktur Metall Anthrazit 160.  
 Ø 45 H. 46 cm



#### PAG 213

Mesita Caruso  
 01. lacado mate pómez 152.  
 02. lacado mate blanco yeso 121.  
 A 44,5 P 44 H 43,1 cm

Table basse Caruso  
 01. laqué ponce 152 mat.  
 02. laqué blanc craie 121 mat.  
 L 44,5 P 44 H 43,1 cm

Beistelltisch Caruso  
 01. matt lackiert Bimsstein 152.  
 02. matt lackiert Gipsweiß 121.  
 B. 44,5 T. 44 H. 43,1 cm



#### PAG 215

Mesita Eclisse lacado mate blanco yeso 121, texturizado con nudos oscuro.  
 A 55 P 45 H 45 cm

Table basse Eclisse laquée blanc craie 121 mat, texturé chêne à nœuds foncé.  
 L 55 P 45 H 45 cm

Beistelltisch Eclisse matt lackiert Gipsweiß 121, Rau astig dunkel.  
 B. 55 T. 45 H. 45 cm



#### PAG 216

Mesitas Brigitte  
 01. Sobre Hpl 11, estructura metal hot 127.  
 Ø 45 H 52 cm  
 02. Sobre Hpl 11, estructura salvia 159.  
 Ø 45 H 52 cm  
 03. Sobre Hpl 11, estructura hot 127.  
 Ø 100 H 30 cm  
 Alfombra Gradient.

Tables basses Brigitte  
 01. Plateau Hpl 11, structure en métal hot 127.  
 Ø 45 H 52 cm  
 02. Plateau Hpl 11, structure sauge 159.  
 Ø 45 H 52 cm  
 03. Plateau Hpl 11, structure hot 127.  
 Ø 100 H 30 cm  
 Tapis Gradient.

Beistelltische Brigitte  
 01. Platte HPL 11, Struktur Metall Hot 127.  
 Ø 45 H. 52 cm  
 02. Platte HPL 11, Struktur Metall Salbei 159.  
 Ø 45 H. 52 cm  
 03. Platte HPL 11, Struktur Hot 127.  
 Ø 100 H. 30 cm  
 Teppich Gradient.



#### PAG 219

Mesita Brigitte sobre Hpl 11, estructura metal hot 127.  
 Ø 45 H 52 cm

Table basse Brigitte plateau en Hpl 11, structure en métal hot 127.  
 Ø 45 H 52 cm

Beistelltisch Brigitte Platte HPL 11, Struktur Metall Hot 127.  
 Ø 45 H. 52 cm



#### PAG 221

Mesitas Brigitte  
 01. lacado mate hot 127.  
 Ø 45 H 52 cm  
 02. sobre texturizado cemento oscuro, estructura metal antracita 160.  
 Ø 45 H 52 cm  
 03. lacado mate blanco yeso 121.  
 Ø 100 H 30 cm  
 04. lacado mate rojo 134.  
 Ø 45 H 52 cm

Tables basses Brigitte  
 01. laqué hot 127 mat.  
 Ø 45 H 52 cm  
 02. plateau en texturé ciment foncé, structure en métal anthracite 160.  
 Ø 45 H 52 cm  
 03. laqué blanc craie 121 mat.  
 Ø 100 H 30 cm  
 04. laqué rouge 134 mat.  
 Ø 45 H 52 cm

Beistelltische Brigitte  
 01. matt lackiert Hot 127.  
 Ø 45 H. 52 cm  
 02. Platte Rau Zement dunkel, Struktur Metall Anthrazit 160.  
 Ø 45 H. 52 cm  
 03. matt lackiert Gipsweiß 121.  
 Ø 100 H. 30 cm  
 04. matt lackiert Rot 134.  
 Ø 45 H. 52 cm



#### PAG 222

A la derecha:  
 Mesitas Strike versión Glamour y White,  
 A la izquierda:  
 Mesitas Strike versión Natural.

À droite:  
 Tables basses Strike version Glamour et White.  
 À gauche:  
 Tables basses Strike version Natural.

Auf der rechten Seite:  
 Beistelltische Strike Version Glamour und White.  
 Auf der linken Seite:  
 Beistelltische Strike Version Natural.



#### PAG 226

Mesitas Bloom sobre cristal transparente 320, estructura madera roble termotratado.  
 Ø 41 H 62 cm  
 Ø 56 H 47 cm  
 Wallpaper WPT534.

Tables basses Bloom plateau en verre transparent 320, structure en bois de chêne thermo-traité.  
 Ø 41 H 62 cm  
 Ø 56 H 47 cm  
 Papier peint WPT 534.

Beistelltische Bloom Platte transparentes Glas 320, Struktur Holz Thermoeiche.  
 Ø 41 H. 62 cm  
 Ø 56 H. 47 cm  
 Wallpaper WPT534.



#### PAG 227

Mesita Bloom sobre cristal transparente 320, estructura madera roble termotratado.  
 Ø 56 H 47 cm

Table basse Bloom plateau en verre transparent 320, structure en bois de chêne thermo-traité.  
 Ø 56 H 47 cm

Beistelltisch Bloom Platte transparentes Glas 320, Struktur Holz Thermoeiche.  
 Ø 56 H. 47 cm



#### PAG 228

Mesita Bloom sobre cristal transparente 320, estructura madera roble termotratado.  
 A 120 P 120 H 40 cm

Table basse Bloom plateau en verre transparent 320, structure en bois de chêne thermo-traité.  
 L 120 P 120 H 40 cm

Beistelltisch Bloom Platte transparentes Glas 320, Struktur Holz Thermoeiche.  
 B. 120 T. 120 H. 40 cm



#### PAG 229

Mesita Bloom sobre cristal transparente 320, estructura madera roble termotratado.  
 A 110 P 60 H 40 cm  
 Cuadros Elegance Style XS.

Table basse Bloom plateau en verre transparent 320, structure en bois de chêne thermo-traité.  
 L 110 P 60 H 40 cm  
 Tableaux Elegance Style XS.

Beistelltisch Bloom Platte transparentes Glas 320, Struktur Holz Thermoeiche.  
 B. 110 T. 60 H. 40 cm  
 Bilder Elenance Style XS.





#### PAG 230

Mesita Flexo sobre lacado mate smoke 128, sobre grande lacado mate blanco yeso 121, estructura metal blanco yeso 121.

Table basse Flexo petit plateau laqué smoke 128 mat, grand plateau laqué blanc craie 121 mat, structure en métal blanc craie 121.

Beistelltisch Flexo Platte matt lackiert Smoke 128, große Platte matt lackiert Gipsweiß 121, Struktur Metall Gipsweiß 121.



#### PAG 233

01. Mesita Flexo lacado mate hot 127.  
A 90 P 75 H 27 cm  
02. Mesita Flexo sobre lacado mate smoke 128, sobre grande lacado mate blanco yeso 121, estructura metal blanco yeso 121.  
A 130/90 P 75 H 30/27 cm  
03. Mesita Senzatempo lacado mate smoke 128.  
A 120 P 60 H 27 cm

01. Table basse Flexo laquée hot 127 mat.  
L 90 P 75 H 27 cm  
02. Table basse Flexo petit plateau laqué smoke 128 mat, grand plateau laqué blanc craie 121 mat, structure en métal blanc craie 121.  
L 130/90 P 75 H 30/27 cm  
03. Table basse Senzatempo laquée smoke 128 mat.  
L 120 P 60 H 27 cm

01. Beistelltisch Flexo matt lackiert Hot 127.  
B. 90 T. 75 H. 27 cm  
02. Beistelltisch Flexo Platte matt lackiert Smoke 128, große Platte matt lackiert Gipsweiß 121, Struktur Metall Gipsweiß 121.  
B. 130/90 T. 75 H. 30/27 cm  
03. Beistelltisch Senzatempo matt lackiert Smoke 128.  
B. 120 T. 60 H. 27 cm



#### PAG 235

01. Mesita 33 versión 11  
02. Mesita 33 versión 13  
03. Mesita 33 versión 12  
04. Mesita 33 versión 10  
Ø 40 H 38 cm  
Wallpaper WPT 515

01. Table basse 33 version 11  
02. Table basse 33 version 13  
03. Table basse 33 version 12  
04. Table basse 33 version 10  
Ø 40 H 38 cm  
Papier peint WPT 515

01. Beistelltisch 33 Version 11.  
02. Beistelltisch 33 Version 13.  
03. Beistelltisch 33 Version 12.  
04. Beistelltisch 33 Version 10.  
Ø 40 H. 38 cm  
Wallpaper WPT 515.



#### PAG 239

Composición con espejos Bolle, acabado espejo.

Composition avec miroirs Bolle, finition miroir.

Zusammenstellung mit Spiegeln Bolle, Spiegelplatte.



#### PAG 241

Espejo Inside compartimentos abiertos metal madreperla 124.  
A 54 P 18 H 180 cm  
Kalista metal antracita 160.  
A 27 P 36 H 80 cm

Miroir Inside avec éléments ouverts en métal nacre 124.  
L 54 P 18 H 180 cm  
Kalista en métal anthracite 160.  
L 27 P 36 H 80 cm

Spiegel Inside offene Abteile Metall Perlmutter 124.  
B. 54 T. 18 H. 180 cm  
Kalista Metall Anthrazit 160.  
B. 27 T. 36 H. 80 cm



#### PAG 242

Espejos Hashtag texturizado mate blanco yeso, perfil lacado mate blanco yeso 121, espejo plateado 381.  
01. Tipo A A 65 H 125 Esp. 3 cm  
02. Tipo B A 65 H 65 Esp. 3 cm  
03. Tipo C A 100 H 72 Esp. 3 cm  
04. Tipo D A 65 H 180 Esp. 3 cm

Miroirs Hashtag en texturé blanc craie mat, profil laqué blanc craie 121 mat, glace argentée 381.  
01. Type A L 65 H 125 EP 3 cm  
02. Type B L 65 H 65 EP 3 cm  
03. Type C L 100 H 72 EP 3 cm  
04. Type D L 65 H 180 EP 3 cm

Spiegel Hashtag Rau matt lackiert Gipsweiß, Profil matt lackiert Gipsweiß 121 / Spiegel in Silberoptik 381.  
01. Typ A B. 65 H. 125 ST. 3 cm  
02. Typ B B. 65 H. 65 ST. 3 cm  
03. Typ C B. 100 H. 72 ST. 3 cm  
04. Typ D B. 65 H. 180 ST. 3 cm



#### PAG 247

Espejo Vip lacado poro abierto madreperla 224.  
A 101,8 H 66,9 Esp. 6 cm

Miroir Vip laqué nacre 224 à pores ouverts.  
L 101,8 H 66,9 EP 6 cm

Spiegel Vip offenporig lackiert Perlmutter 224.  
B. 101,8 H. 66,9 ST. 6 cm



#### PAG 249

Espejo Dolcevida madera lacada poro abierto blanco yeso 221.  
A 126 H 78 Esp. 6,5 cm

Miroir Dolcevida en bois laqué blanc craie 221 à pores ouverts.  
L 126 H 78 SP 6,5 cm

Spiegel Dolcevida Holz offenporig lackiert Gipsweiß 221.  
B. 126 H. 78 ST. 6,5 cm



#### PAG 252

Kalista  
01. metal blanco yeso 121.  
02. metal antracita 160.

03. metal salvia 159.  
04. metal azafrán 158.  
05. metal azul niño 155.  
06. metal burdeos 156.  
A 27 P 36 H 80 cm  
Wallpaper WPT 512.

Kalista  
01. métal blanc craie 121.  
02. métal anthracite 160.  
03. métal sauge 159.  
04. métal safran 158.  
05. métal bleu pastel 155.  
06. métal bordeaux 156.  
L 27 P 36 H 80 cm  
Papier peint WPT 512.

Kalista  
01. Metall Gipsweiß 121.  
02. Metall Anthrazit 160.  
03. Metall Salbei 159.  
04. Metall Safrangelb 158.  
05. Metall Pastellblau 155.  
06. Metall Bordeaux 156.  
B. 27 T. 36 H. 80 cm  
Wallpaper WPT 512.



#### PAG 253

Kalista metal madreperla 124.  
A 27 P 36 H 80 cm

Kalista métal nacre 124.  
L 27 P 36 H 80 cm

Kalista Metall Perlmutter 124.  
B. 27 T. 36 H. 80 cm



#### PAG 254

Kalista Midi estructura metal blanco yeso 121.  
A 60 P 40 H 160 cm

Kalista Midi structure en métal blanc craie 121.  
L 60 P 40 H 160 cm

Kalista Midi Struktur Metall Gipsweiß 121.  
B. 60 T. 40 H. 160 cm



#### PAG 255

Kalista Costado estructura metal blanco yeso 121.  
A 45 P 24 H 210 cm

Kalista Fianco structure en métal blanc craie 121.  
L 45 P 24 H 210 cm

Kalista f. Schrankseite Struktur Metall Gipsweiß 121.  
B. 45 T. 24 H. 210 cm



#### PAG 256

Librería Movida estructura metal blanco yeso 121, estantes texturizado con nudos oscuro.  
A 38 P 38 H 190 cm  
A 74 P 38 H 190 cm  
Silla Tiffany estructura madera lacada poro abierto antracita 260, revestimiento cat. b ecopiel vintage 107.  
A 46 P 50 H 83/47 cm  
Puf Comodo 03.  
A 85 P 85 H 85 cm

Bibliothèque Movida structure en métal blanc craie 121, tablettes en texturé chêne à nœuds foncé.  
L 38 P 38 H 190 cm  
L 74 P 38 H 190 cm  
Chaise Tiffany structure en bois laqué anthracite 260 à pores ouverts, revêtement cat. b écocuir vintage 107.  
L 46 P 50 H 83/47 cm  
Pouf Comodo 03.  
L 85 P 85 H 85 cm

Bücherregal Movida Struktur Metall Gipsweiß 121, Fachböden Rau astig dunkel.  
B. 38 T. 38 H. 190 cm  
B. 74 T. 38 H. 190 cm  
Stuhl Tiffany Struktur Holz offenporig lackiert Anthrazit 260, Bezug Kat. B Lederimitat Vintage 107.  
B. 46 T. 50 H. 83/47 cm  
Hocker Comodo 03.  
B. 85 T. 85 H. 85 cm





#### PAG 259

Librería Movida estructura metal antracita 160, estantes texturizado con nudos oscuro.

A 74 P 38 H 190 cm  
Escritorio Raster sobre texturizado con nudos oscuro, estructura metal antracita 160.  
A 120 P 70 H 87 cm  
Puf Guccino cat. b econobuk 05, lacado mate madreperla 124. Ø 40 H 53 cm

Bibliothèque Movida structure en métal anthracite 160, tablettes en texturé chène à nœuds foncé.

L 74 P 38 H 190 cm  
Bureau Raster plateau en texturé chène à nœuds foncé, structure en métal anthracite 160.  
L 120 P 70 H 87 cm  
Pouf Guccino cat. b econobuk 05, laqué nacre 124 mat. Ø 40 H 53 cm

Bücherregal Movida Struktur Metall Anthrazit 160, Fachböden Rau astig dunkel.  
B. 74 T. 38 H. 190 cm  
Schreibpult Raster Platte Rau astig dunkel, Struktur Metall Anthrazit 160.  
B. 120 T. 70 H. 87 cm  
Hocker Guccino Kat. B Econabuk 05, matt lackiert Perlmutter 124. Ø 40 H. 53 cm



#### PAG 260

Raster compartimentos abiertos horizontales y verticales en múltiples combinaciones de color.  
Raster horizontal: A 144 P 30,5 H 18 cm  
Raster vertical: A 18 P 30,5 H 144 cm

Raster casiers horizontaux et verticaux déclinés en de multiples combinaisons de couleur.  
Casier Raster horizontal : L 144 P 30,5 H 18 cm  
Casier Raster vertical : L 18 P 30,5 H 144 cm

Raster Waagrechte und senkrechte offene Fächer in unzähligen Farbkombinationen.  
Waagrechtes Element Raster: B. 144 T. 30,5 H. 18 cm  
Senkrecht Element Raster: B. 18 T. 30,5 H. 144 cm



#### PAG 263

Raster suspendidos estructura metal antracita 160, aplicaciones y trasera en texturizado fresno oriente.

A 144 P 30 H 18 cm  
Casiers Raster suspendus structure en métal anthracite 160, séparations et fonds en texturé frêne orient.

L 144 P 30 H 18 cm  
Wandhängende Elemente Raster Struktur Metall Anthrazit 160, Einsätze und Rückwand in Rau Esche Oriente.  
B. 144 T. 30 H. 18 cm



#### PAG 265

Estantes Ring texturizado con nudos claro, metal blanco yeso 121.

A 144 P 25,6 H 27,1 cm  
Étagères Ring en texturé chène à nœuds clair, métal blanc craie 121.  
L 144 P 25,6 H 27,1 cm

Borde Ring Rau astig hell, Metall Gipsweiß 121.  
B. 144 T. 25,6 H. 27,1 cm



#### PAG 266

Ciko varias combinaciones espejo, colores, acabados

y decoraciones.  
A 36 P 24 H 36 cm

Ciko diverses combinaisons possibles entre miroir, coloris laqués, finitions bois et décors graphiques.  
L 36 P 24 H 36 cm

Ciko - verschiedene Kombinationen mit Spiegel, Farben, Ausführungen und Grafikmustern.  
B. 36 T. 24 H. 36 cm



#### PAG 270

Colgantes Petalo metal burdeos 156.  
A 60/80 H 22 P 18 cm  
Wallpaper WPT 536.

Éléments hauts Petalo en métal bordeaux 156.  
L 60/80 H 22 P 18 cm  
Papier peint WPT 536.

Wandelemente Petalo Metall Bordeaux 156.  
B. 60/80 H. 22 T. 18 cm  
Wallpaper WPT 536.



#### PAG 271

Colgantes Petalo metal salvia 159.  
A 60/80 H 22 P 18 cm  
Wallpaper WPT 550.

Éléments hauts Petalo en métal sauge 159.  
L 60/80 H 22 P 18 cm  
Papier peint WPT 550.

Wandelemente Petalo Metall Salbei 159.  
B. 60/80 H. 22 T. 18 cm  
Wallpaper WPT 550.



#### PAG 272

Escritorio Atlante sobre texturizado con nudos claro, estructura metal antracita 160.  
A 120 P 70 H 87 cm  
Puf Guccino cat. b econobuk 05, lacado mate madreperla 124. Ø 40 H 53 cm

Bureau Atlante plateau en texturé chène à nœuds clair, structure en métal anthracite 160.  
L 120 P 70 H 87 cm  
Pouf Guccino cat. b econobuk 05, laqué nacre 124 mat. Ø 40 H 53 cm

Schreibpult Atlante Platte Rau Zement hell, Struktur Metall Anthrazit 160.  
B. 120 T. 70 H. 87 cm  
Hocker Guccino Kat. B Econabuk 05, matt lackiert Perlmutter 124. Ø 40 H. 53 cm



#### PAG 275

Escritorio lacado mate blanco yeso 121.  
A 120 P 70 H 87 cm  
Silla Tiffany con estructura madera lacada poro abierto blanco yeso 221, revestimiento cat. b ecopiel 34.  
A 46 P 50 H 83/47 cm

Wallpaper WPT 507.

Bureau laqué blanc craie mat 121.  
B. 120 T. 70 H. 87 cm  
Chaise Tiffany structure en bois laqué blanc craie 221 à pores ouverts, revêtement cat. b écocuir 34.  
L 46 P 50 H 83/47 cm  
Papier peint WPT 507.

Schreibpult matt lackiert Gipsweiß 121.  
B. 120 T. 70 H. 87 cm  
Stuhl Tiffany Struktur Holz offenporig lackiert Gipsweiß 221, Bezug Kat. B Lederimitat 34.  
B. 46 T. 50 H. 83/47 cm  
Wallpaper WPT 507.



#### PAG 277

Escritorio sobre texturizado con nudos claro, estructura metal blanco yeso 121.  
L 120 P 70 H 87 cm  
Raster Horizontal estructura metal blanco yeso 121, texturizado con nudos claro.  
A 144 P 30 H 18 cm  
Wallpaper WPT 527.

Bureau plateau en texturé chène à nœuds clair, structure en métal blanc craie 121.  
L 120 P 70 H 87 cm  
Casier Raster horizontal structure en métal blanc craie 121, séparations et fonds en texturé chène à nœuds clair.  
L 144 P 30 H 18 cm  
Papier peint WPT 527.

Schreibpult Platte Rau astig hell, Struktur Metall Gipsweiß 121.  
B. 120 T. 70 H. 87 cm  
Waagrechtes Element Raster Struktur Metall Gipsweiß 121, Rau astig hell.  
B. 144 T. 30 H. 18 cm  
Wallpaper WPT 527.



#### PAG 278

Banco Panketta 01. texturizado con nudos oscuro y estructura metal blanco yeso 121.  
A 216 P 38 H 45 cm  
02. lacado mate blanco yeso 121.  
A 216 P 38 H 45 cm  
03. texturizado con nudos claro y estructura metal antracita 160.  
A 144 P 38 H 45 cm

Panketta 01. texturé chène à nœuds foncé et structure en métal blanc craie 121.  
L 216 P 38 H 45 cm  
02. laqué blanc craie 121 mat.  
L 216 P 38 H 45 cm  
03. texturé chène à nœuds clair et structure en métal anthracite 160.  
L 144 P 38 H 45 cm

Panketta 01. Rau astig dunkel und Struktur Metall Gipsweiß 121.  
B. 216 T. 38 H. 45 cm

02. matt lackiert Gipsweiß 121.  
B. 216 T. 38 H. 45 cm  
03. Rau astig hell und Struktur Metall Anthrazit 160.  
B. 144 T. 38 H. 45 cm



#### PAG 281

Banco Panketta texturizado con nudos claro estructura metal antracita 160.  
A 144 P 38 H 45 cm

Panketta en texturé chène à nœuds clair, structure en métal anthracite 160.  
L 144 P 38 H 45 cm

Panketta Rau astig hell, Struktur Metall Anthrazit 160.  
B. 144 T. 38 H. 45 cm



#### PAG 282

Tasca Izquierda: tejido cat. b texas col. 25 y bolsillos en tejido cat. b texas col. 12.  
Derecha: tejido cat. b texas col. 10 y bolsillos en tejido cat. b texas col. 31.  
A 80 H 720 cm

Tasca À gauche : tissu cat. b texas col. 25 et poches en tissu cat. b texas col. 12.  
À droite : tissu cat. b texas col. 10 et poches en tissu cat. b texas col. 31.  
L 80 H 720 cm

Tasca Links: Stoff Kat. B Texas Farbe 25 und Taschen aus Stoff Kat. B Texas Farbe 12.  
Rechts: Stoff Kat. B Texas Farbe 10 und Taschen aus Stoff Kat. B Texas Farbe 31.  
B. 80 H. 720 cm





#### PAG 283

Tasca Fianco fondo en ecopiel vintage 102, bolsillos en ecopiel vintage 107.  
A 60 H 230 cm

Tasca Fianco fond en écocuir vintage 102, poches en écocuir vintage 107.  
L 60 H 230 cm

Tasca f. Schrankseite Untergrund aus Lederimitat Vintage 102, Taschen aus Lederimitat Vintage 107.  
B. 60 H. 230 cm



#### PAG 287

Composición Shape 5B lacado mate blanco yeso 121.  
Mesa Brigitte lacado mate blanco yeso 121.  
Ø 120 H 75 cm.  
Silla Betty cat. b ecopiel extrema 01.  
A 45 P 54 H 81/46 cm.

Composition Shape 5B laquée blanc craie 121 mat.  
Table Brigitte laquée blanc craie 121 mat.  
Ø 120 H 75 cm  
Chaise Betty cat.b écocuir extrema 01.  
L 45 P 54 H 81/46 cm

Zusammenstellung Shape 5B matt lackiert Gipsweiß 121.  
Tisch Brigitte matt lackiert Gipsweiß 121.  
Ø 120 H. 75 cm  
Stuhl Betty Kat. B Lederimitat Extrema 01.  
B. 45 T. 54 H. 81/46 cm



#### PAG 289

Composición Shape 5A, acabado peltre y texturizado mate antracita 160.

Composition Shape 5A, finition étain et texturé anthracite 160 mat.

Zusammenstellung Shape 5A, Ausführung Zinn und Rau matt Anthrazit 160.



#### PAG 295

Up&Down roble con nudos natural.  
Puf Giglio cat. 1/one point 06, cat. b ecopiel vintage 103  
A 85 P 85 H 30 cm

Up&Down chêne à nœuds naturel.  
Pouf Giglio cat. 1/one point 06, cat.b écocuir vintage 103.  
L 85 P 85 H 30 cm

Up&Down Eiche astig Natur.  
Hocker Giglio Kat. 1/One Point 06, Kat. B Lederimitat Vintage 103.  
B. 85 T. 85 H. 30 cm



#### PAG 298

Lettering Music metal blanco yeso 121.

Lettering Music en métal blanc craie 121.

Lettering Music Metall Gipsweiß 121.



#### PAG 299

Lettering Me&You metal antracita 160.

Lettering Me&You en métal anthracite 160.

Lettering Me&You Metall Anthrazit 160.



#### PAG 285

Tocador Replay sobre texturizado roble termotratado, estructura metal antracita 160.  
A 120 P 44 H 77 cm  
Puf Cookie cat. c casale 100.  
A 46 P 47 H 47 cm  
Wallpaper WPT 552.

Coiffeuse Replay plateau en texturé chêne thermo-traité, structure en métal anthracite 160.  
L 120 P 44 H 77 cm  
Pouf Cookie cat.c casale 100.  
L 46 P 47 H 47 cm  
Papier peint WPT 552.

Schminktisch Replay Platte Rau Thermoeiche, Struktur Metall Anthrazit 160.  
B. 120 T. 44 H. 77 cm  
Hocker Cookie Kat. C Casale 100.  
B. 46 T. 47 H. 47 cm  
Wallpaper WPT 552.



#### PAG 288

Shape composición 1B texturizado con nudos claro, lacado mate madreperla 124, lacado mate melocotón 157.  
Wallpaper WPT511.

Shape composition 1B texturé à nœuds clair, laqué nacre 124 mat, laqué pêche 157 mat.  
Papier peint WPT511.

Zusammenstellung Shape 1B Rau astig hell, matt lackiert Perlmutter 124, matt lackiert Pfirsich 157.  
Wallpaper WPT511.



#### PAG 293

Mueble recibidor I01 lacado mate madreperla 124, texturizado fresno oriente, Raster metal antracita 160, aplicaciones texturizado fresno oriente.  
A 180 P 30-40 H 234 cm  
Puf Cookie cat. c linara 02, hilo rojo 0856.  
Espejo Bolle. Ø 27-35-55.  
Reloj 630.

Entrée I01 en laqué nacre 124 mat, texturé frêne orient.  
Casier Raster en métal anthracite 160, piètement texturé frêne orient.  
L 180 P/D 30-40 H 234 cm  
Pouf Cookie cat.c linara 02, fil rouge 0856.  
Miroir Bolle. Ø 27-35-55.  
Horloge 630.

Diele I01 matt lackiert Perlmutter 124, Rau Esche Oriente.  
Element Raster Metall Anthrazit 160, Grundgestell Rau Esche Oriente.  
B. 180 - T. 30-40 H. 234 cm  
Hocker Cookie Kat. C Linara 02, Ziernaht Rot 0856.  
Spiegel Bolle. Ø 27-35-55.  
Uhr 630.



#### PAG 297

Clock collection 9 decoraciones distintas para personalizar el reloj de pared.  
Ø 45 - espesor 3,3 cm

Clock collection 9 divers décors graphiques pour personnaliser l'horloge murale.  
Ø 45 - épaisseur 3,3 cm

Clock collection - 9 verschiedene Grafikmuster für eine individuelle Gestaltung der Wanduhr.  
Ø 45 - Stärke 3,3 cm

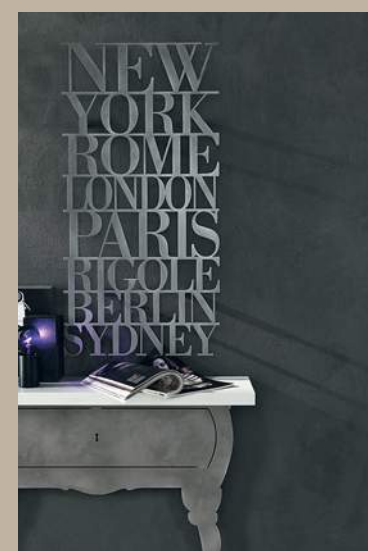

#### PAG 298

Lettering City acabado peltre.

Lettering City finition étain.

Lettering City Ausführung Zinn.



#### PAG 316

01. Manta Lino Saco medidas 150x195 cm.  
02. Manta Militare medidas medidas 150x195 cm.  
03. Manta Cuzco medidas 150x195 cm.

01. Plaid Lino Sacco dimensiones 150x195 cm.  
02. Plaid Militare dimensiones 150x195 cm.  
03. Plaid Cuzco dimensiones 150x195 cm.

01. Plaid Leino Sacco Maße 150x195 cm  
02. Plaid Militare Maße 150x195 cm  
03. Plaid Cuzco Maße 150x195 cm



E' vietata ogni riproduzione totale e parziale in Italia e all'estero.

Reproduction of all or any part of this publication in Italy or in any other country is prohibited.



product design  
ROSSI & CO.  
art direction and styling  
ROSSI & CO.  
graphic design  
ROSSI & CO.  
photography  
STUDIO INDOOR  
color separation  
Z13  
print  
OGM





TOMASELLA.IT

